

TRUSSES

1.0 INTRODUCTION

Trusses are triangular frame works in which the members are subjected to essentially axial forces due to externally applied load. They may be plane trusses [Fig. 1(a)], wherein the external load and the members lie in the same plane or space trusses [Fig. 1(b)], in which members are oriented in three dimensions in space and loads may also act in any direction. Trusses are frequently used to span long lengths in the place of solid web girders and such trusses are also referred to as lattice girders.

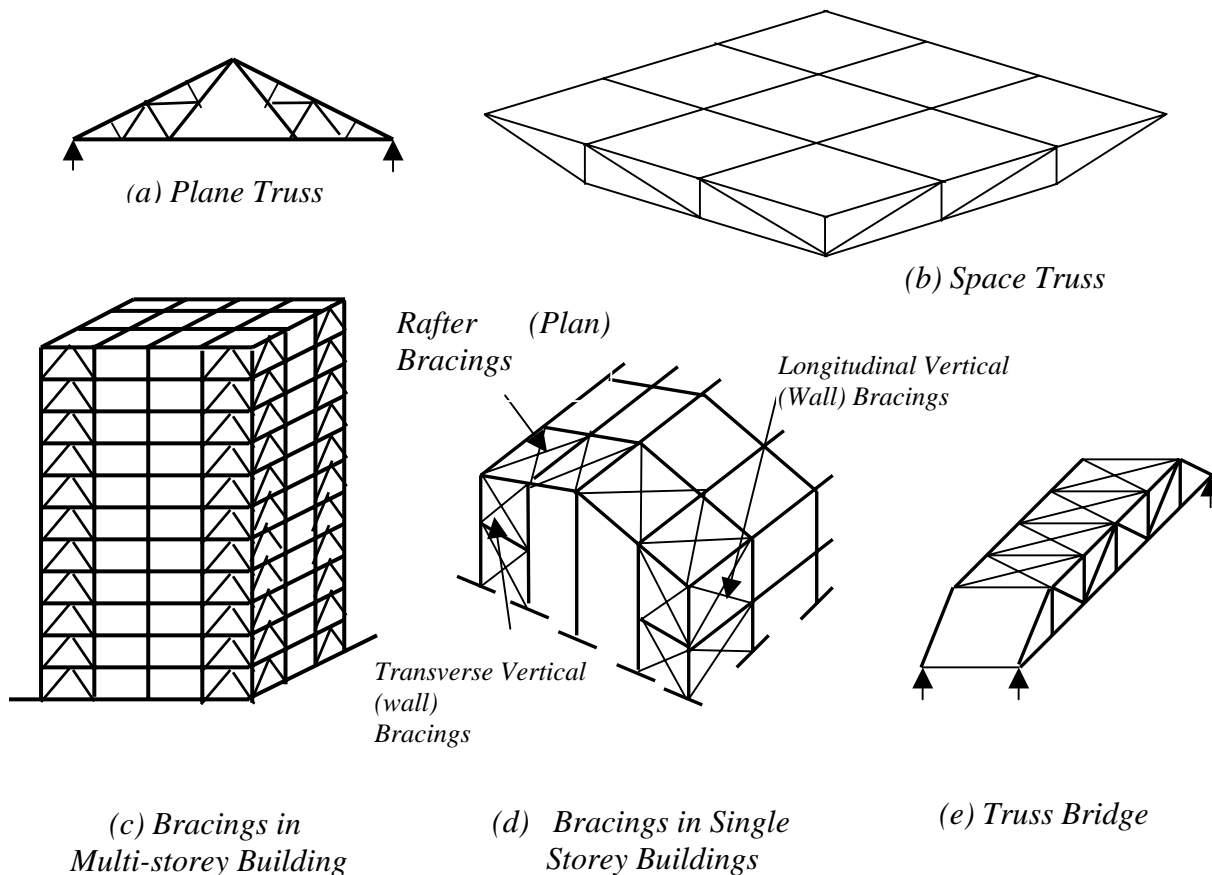

Fig. 1 Types of Trusses

Steel members subjected to axial forces are generally more efficient than members in flexure since the cross section is nearly uniformly stressed. Trusses, consisting of essentially axially loaded members, thus are very efficient in resisting external loads. They are extensively used, especially to span large gaps. Since truss systems consume relatively less material and more labour to fabricate, compared to other systems, they are particularly suited in the Indian context.

© Copyright reserved

Trusses are used in roofs of single storey industrial buildings, long span floors and roofs of multistorey buildings, to resist gravity loads [Figs. 1(a) and 1(b)]. Trusses are also used in multi-storey buildings and walls and horizontal planes of industrial buildings to resist lateral loads and give lateral stability [Figs. 1(c) and 1(d)]. Trusses are used in long span bridges to carry gravity loads and lateral loads [Fig. 1(e)].

Trusses often serve the action of the girder in transferring the gravity load over larger span, and are referred to also as lattice girders. Such lattice girders are usually deeper and much lighter than regular girders and hence are economical, particularly when repetitive fabrication is taken advantage of. These are used as flooring support systems in multi-storey buildings, within which depth all the ducts can be easily accommodated without increasing the depth of the ceiling.

Steel trusses can also be efficiently used along with concrete slabs in buildings and bridges by mobilising composite action between structural steel and concrete. In this chapter, initially, the details of structural steel trusses are discussed. Subsequently, the behaviour and design of structural steel - concrete composite trusses are discussed.

2.0 LOADS

The loads on trusses would depend upon the application for which the trusses are used. The loads may be static, as in the case of buildings, or dynamic, as in the case of bridges. These are briefly reviewed below.

2.1 Industrial Buildings

The roof trusses in industrial buildings are subjected to the following loads:

2.1.1 Dead load

Dead load on the roof trusses in single storey industrial buildings consists of dead load of claddings and dead load of purlins, self weight of the trusses in addition to the weight of bracings etc. Further, additional special dead loads such as truss supported hoist dead loads, special ducting and ventilator weight etc. could contribute to roof truss dead loads. As the clear span length (column free span length) increases, the self weight of the moment resisting gable frame increases drastically. In such cases roof trusses are more economical.

2.1.2 Live load

The live load on roof trusses consist of the gravitational load due to erection and servicing as well as dust load etc. and the intensity is taken as per [IS:875-1987 \(Reaffirmed 1992\)](#). Additional special live loads such as snow loads in very cold climates, crane live loads in trusses supporting monorails may have to be considered.

2.1.3 Wind load

Wind load on the roof trusses, unless the roof slope is too high, would be usually uplift force perpendicular to the roof, due to suction effect of the wind blowing over the roof. Hence the wind load on roof truss usually acts opposite to the gravity load, and its magnitude can be larger than gravity loads, causing reversal of forces in truss members.

The horizontal and vertical bracings employed in single and multi-storey buildings are also trusses [Fig. 1(d)], used primarily to resist wind and other lateral loads. These bracings minimize the differential deflection between the different frames due to crane surge in industrial buildings. They also provide lateral support to columns in small and tall buildings, thus increasing the buckling strength.

2.1.4 Earthquake load

Since earthquake load on a building depends on the mass of the building, earthquake loads usually do not govern the design of light industrial steel buildings. Wind loads usually govern. However, in the case of industrial buildings with a large mass located at the roof, the earthquake load may govern the design. These loads are calculated as per [IS:1893-1985](#).

2.2 Multi-Storey Buildings

The lateral load due to wind or earthquake may be resisted by vertical bracings acting as trusses. These bracings, properly designed, make these buildings very stiff in resisting lateral loads. Hence they are economical in the buildings of intermediate height ranges. In the case of earthquake loading, stiff buildings may attract larger inertia force and hence use of bracings may not be desirable.

2.3 Bridge Trusses

Trusses are used in bridges to transfer the gravity load of moving vehicles to supporting piers. Depending upon the site conditions and the span length of the bridge, the truss may be either through type or deck type. In the through type, the carriage way is supported at the bottom chord of trusses. In the deck type bridge, the carriage way is supported at the top chord of trusses. Usually, the structural framing supporting the carriage way is designed such that the loads from the carriage way are transferred to the nodal points of the vertical bridge trusses. More details of the trusses bridges are discussed in the chapter on bridges.

3.0 ANALYSIS OF TRUSSES

Generally truss members are assumed to be joined together so as to transfer only the axial forces and not moments and shears from one member to the adjacent members (they are regarded as being pinned joints). The loads are assumed to be acting only at the nodes of the trusses. The trusses may be provided over a single span, simply supported over the

two end supports, in which case they are usually statically determinate. Such trusses can be analysed manually by the method of joints or by the method of sections. Computer programs are also available for the analysis of trusses. These programs are more useful in the case of multi-span indeterminate trusses, as well as in the case of trusses in which the joint rigidity has to be considered. The effect of joint rigidity is discussed later in greater detail.

From the analysis based on pinned joint assumption, one obtains only the axial forces in the different members of the trusses. However, in actual design, the members of the trusses are joined together by more than one bolt or by welding, either directly or through larger size end gussets. Further, some of the members, particularly chord members, may be continuous over many nodes. Generally such joints enforce not only compatibility of translation but also compatibility of rotation of members meeting at the joint. As a result, the members of the trusses experience bending moment in addition to axial force. This may not be negligible, particularly at the eaves points of pitched roof trusses, where the depth is small and in trusses with members having a smaller slenderness ratio (i.e. stocky members). Further, the loads may be applied in between the nodes of the trusses, causing bending of the members. Such stresses are referred to as secondary stresses. The secondary bending stresses can be caused also by the eccentric connection of members at the joints. The analysis of trusses for the secondary moments and hence the secondary stresses can be carried out by an indeterminate structural analysis, usually using computer software.

The magnitude of the secondary stresses due to joint rigidity depends upon the stiffness of the joint and the stiffness of the members meeting at the joint. Normally the secondary stresses in roof trusses may be disregarded, if the slenderness ratio of the chord members is greater than 50 and that of the web members is greater than 100. The secondary stresses cannot be neglected when they are induced due to application of loads on members in between nodes and when the members are joined eccentrically. Further the secondary stresses due to the rigidity of the joints cannot be disregarded in the case of bridge trusses due to the higher stiffness of the members and the effect of secondary stresses on fatigue strength of members. In bridge trusses, often misfit is designed into the fabrication of the joints to create prestress during fabrication opposite in nature to the secondary stresses and thus help improve the fatigue performance of the truss members at their joints.

3.0 CONFIGURATION OF TRUSSES

3.1 Pitched Roof Trusses

Most common types of roof trusses are pitched roof trusses wherein the top chord is provided with a slope in order to facilitate natural drainage of rainwater and clearance of dust/snow accumulation. These trusses have a greater depth at the mid-span. Due to this even though the overall bending effect is larger at mid-span, the chord member and web member stresses are smaller closer to the mid-span and larger closer to the supports. The typical span to maximum depth ratios of pitched roof trusses are in the range of 4 to 8,

the larger ratio being economical in longer spans. Pitched roof trusses may have different configurations. In Pratt trusses [Fig. 2(a)] web members are arranged in such a way that under gravity load the longer diagonal members are under tension and the shorter vertical members experience compression. This allows for efficient design, since the short members are under compression. However, the wind uplift may cause reversal of stresses in these members and nullify this benefit. The converse of the Pratt is the Howe truss [Fig. 2(b)]. This is commonly used in light roofing so that the longer diagonals experience tension under reversal of stresses due to wind load.

Fink trusses [Fig. 2(c)] are used for longer spans having high pitch roof, since the web members in such truss are sub-divided to obtain shorter members.

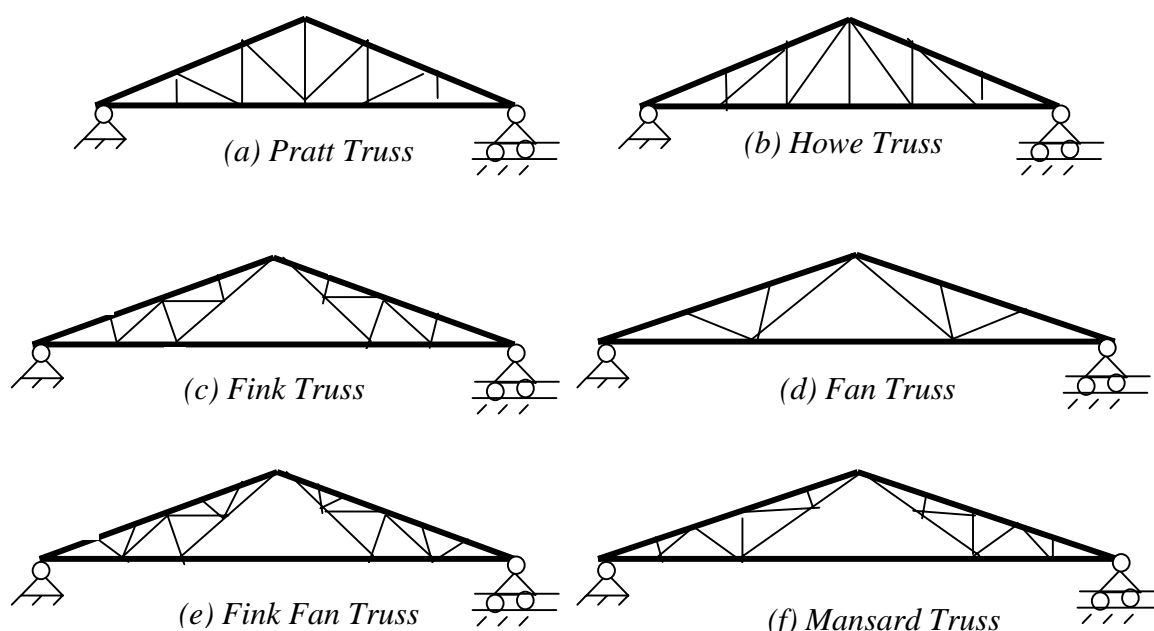

Fig. 2 Pitched Roof Trusses

Fan trusses [Fig. 2(d)] are used when the rafter members of the roof trusses have to be sub-divided into odd number of panels. A combination of fink and fan [Fig. 2(e)] can also be used to some advantage in some specific situations requiring appropriate number of panels.

Mansard trusses [Fig. 2(f)] are variation of fink trusses, which have shorter leading diagonals even in very long span trusses, unlike the fink and fan type trusses.

The economical span lengths of the pitched roof trusses, excluding the Mansard trusses, range from 6 m to 12 m. The Mansard trusses can be used in the span ranges of 12 m to 30 m.

3.2 Parallel Chord Trusses

The parallel chord trusses are used to support North Light roof trusses in industrial buildings as well as in intermediate span bridges. Parallel chord trusses are also used as pre-fabricated floor joists, beams and girders in multi-storey buildings [Fig. 3(a)]. Warren configuration is frequently used [Figs. 3(b)] in the case of parallel chord trusses. The advantage of parallel chord trusses is that they use webs of the same lengths and thus reduce fabrication costs for very long spans. Modified Warren is used with additional verticals, introduced in order to reduce the unsupported length of compression chord members. The saw tooth north light roofing systems use parallel chord lattice girders [Fig. 3(c)] to support the north light trusses and transfer the load to the end columns.

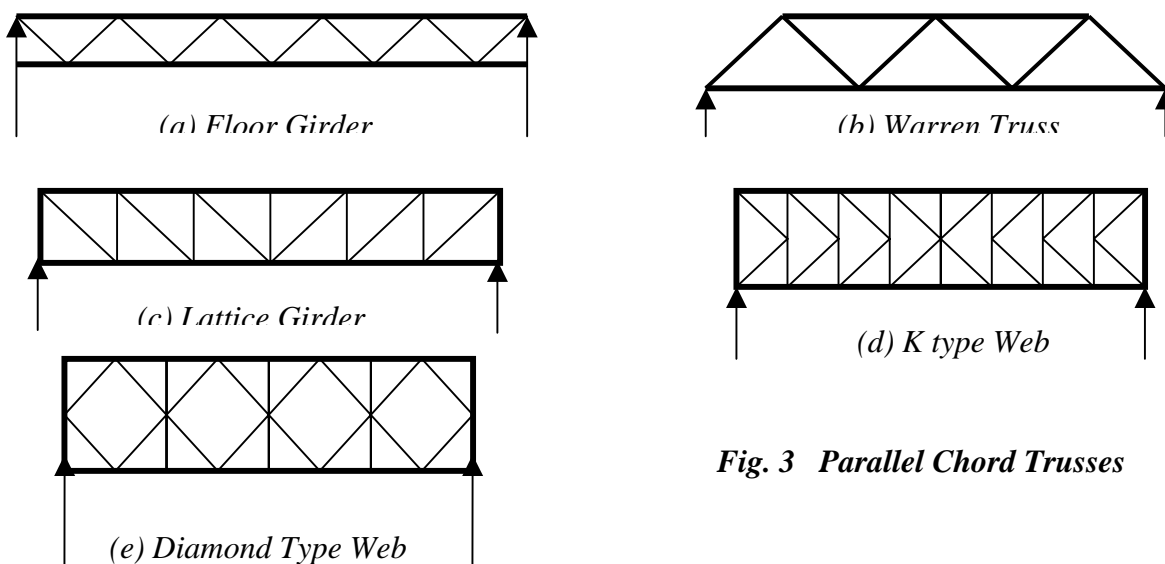

Fig. 3 Parallel Chord Trusses

The economical span to depth ratio of the parallel chord trusses is in the range of 12 to 24. The total span is subdivided into a number of panels such that the individual panel lengths are appropriate (6m to 9 m) for the stringer beams, transferring the carriage way load to the nodes of the trusses and the inclination of the web members are around 45 degrees. In the case of very deep and very shallow trusses it may become necessary to use K and diamond patterns for web members to achieve appropriate inclination of the web members. [Figs. 3(d), 3(e)]

3.3 Trapezoidal Trusses

In case of very long span length pitched roof, trusses having trapezoidal configuration, with depth at the ends are used [Fig. 4(a)]. This configuration reduces the axial forces in the chord members adjacent to the supports. The secondary bending effects in these members are also reduced. The trapezoidal configurations [Fig. 4(b)] having the sloping bottom chord can be economical in very long span trusses (spans > 30 m), since they tend to reduce the web member length and the chord members tend to have nearly constant forces over the span length. It has been found that bottom chord slope equal to nearly half as much as the rafter slope tends to give close to optimum design.

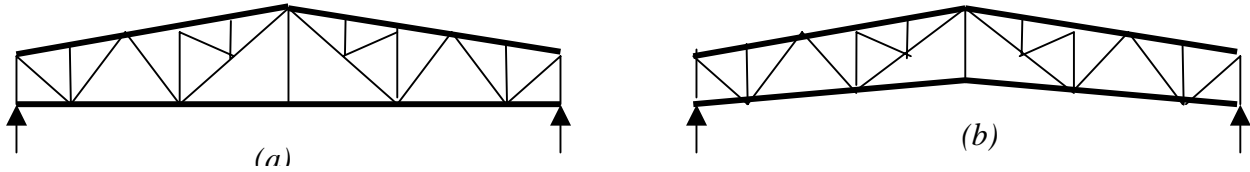

Fig 4. Trapezoidal Trusses

4.0 TRUSS MEMBERS

The members of trusses are made of either rolled steel sections or built-up sections depending upon the span length, intensity of loading, etc. Rolled steel angles, tee sections, hollow circular and rectangular structural tubes are used in the case of roof trusses in industrial buildings [Fig. 5(a)]. In long span roof trusses and short span bridges heavier rolled steel sections, such as channels, I sections are used [Fig. 5(b)]. Members built-up using I sections, channels, angles and plates are used in the case of long span bridge trusses [Fig. 5(c)]

Access to surface, for inspection, cleaning and repainting during service, are important considerations in the choice of the built-up member configuration. Surfaces exposed to the environments, but not accessible for maintenance are vulnerable to severe corrosion during life, thus reducing the durability of the structure. In highly corrosive environments fully closed welded box sections, and circular hollow sections are used to reduce the maintenance cost and improve the durability of the structure.

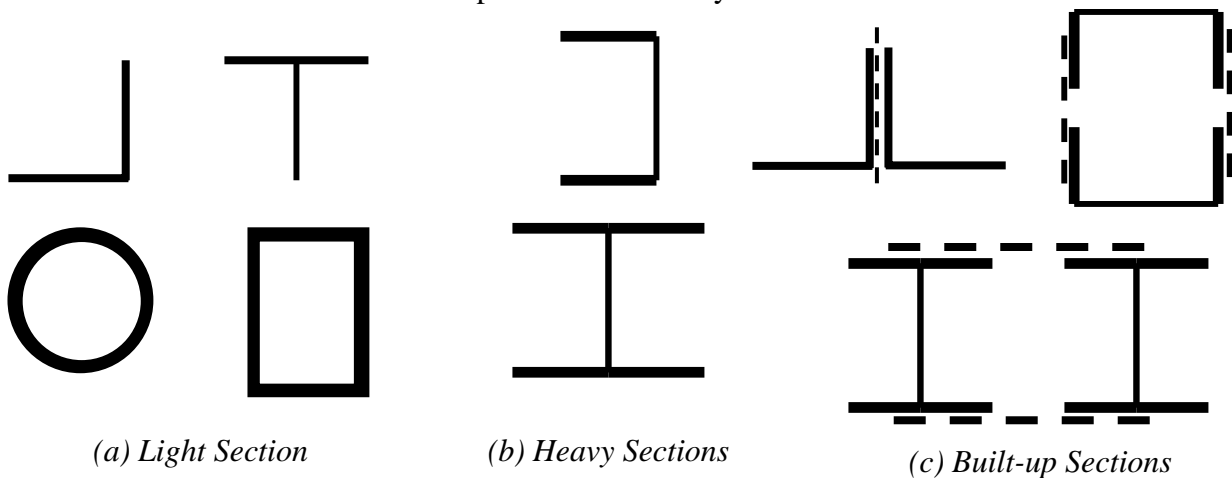

Fig. 5 Cross Sections of Truss Members

5.0 CONNECTIONS

Members of trusses can be joined by riveting, bolting or welding. Due to involved procedure and highly skilled labour requirement, riveting is not common these days,

except in some railway bridges in India. In railway bridges riveting may be used due to fatigue considerations. Even in such bridges, due to recent developments, high strength friction grip (HSFG) bolting and welding have become more common. Shorter span trusses are usually fabricated in shops and can be completely welded and transported to site as one unit. Longer span trusses can be prefabricated in segments by welding in shop. These segments can be assembled by bolting or welding at site. This results in a much better quality of the fabricated structure. However, the higher cost of shop fabrication due to excise duty in contrast to lower field labour cost frequently favour field fabrication in India.

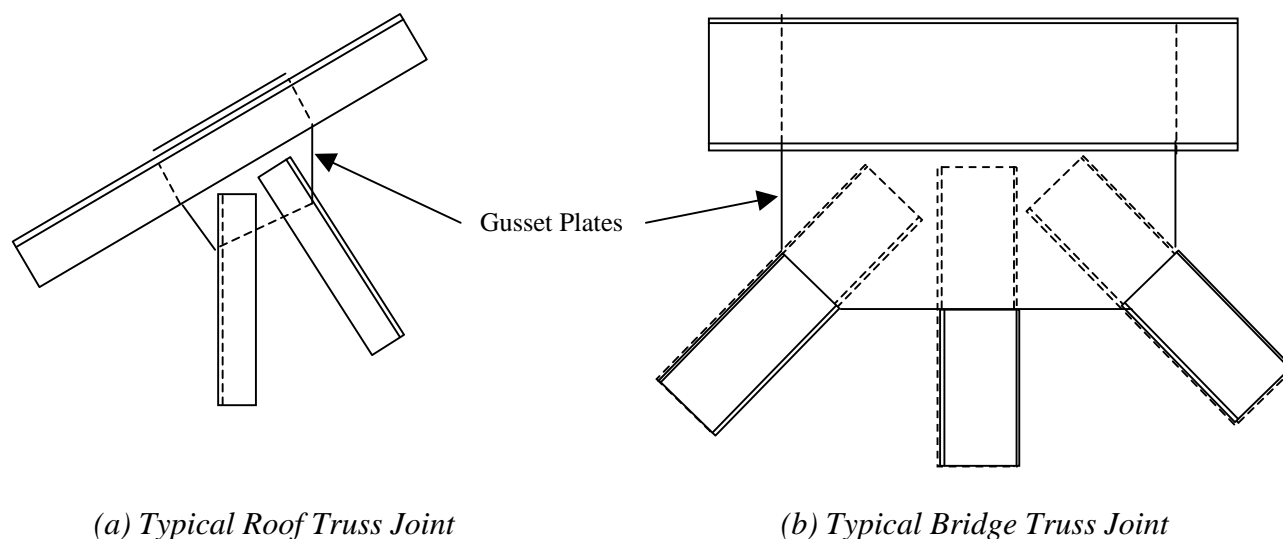

Fig. 6 Typical Truss Joints

If the rafter and tie members are T sections, angle diagonals can be directly connected to the web of T by welding or bolting. Frequently, the connections between the members of the truss cannot be made directly, due to inadequate space to accommodate the joint length. In such cases, gusset plates are used to accomplish such connections (Fig. 6). The size, shape and the thickness of the gusset plate depend upon the size of the member being joined, number and size of bolt or length of weld required, and the force to be transmitted. The thickness of the gusset is in the range of 8 mm to 12 mm in the case of roof trusses and it can be as high as 22 mm in the case of bridge trusses. The design of gussets is usually by rule of thumb. In short span (8 – 12 m) roof trusses, the member forces are smaller, hence the thickness of gussets are lesser (6 or 8 mm) and for longer span lengths (> 30 m) the thickness of gussets are larger (12 mm). The design of gusset connections are discussed in a chapter on connections.

6.0 DESIGN OF TRUSSES

Factors that affect the design of members and the connections in trusses are discussed in this section.

6.1 Instability Considerations

While trusses are stiff in their plane they are very weak out of plane. In order to stabilize the trusses against out- of- plane buckling and to carry any accidental out of plane load, as well as lateral loads such as wind/earthquake loads, the trusses are to be properly braced out -of -plane. The instability of compression members, such as compression chord, which have a long unsupported length out- of-plane of the truss, may also require lateral bracing.

Compression members of the trusses have to be checked for their buckling strength about the critical axis of the member. This buckling may be in plane or out-of-plane of the truss or about an oblique axis as in the case of single angle sections. All the members of a roof truss usually do not reach their limit states of collapse simultaneously. Further, the connections between the members usually have certain rigidity. Depending on the restraint to the members under compression by the adjacent members and the rigidity of the joint, the effective length of the member for calculating the buckling strength may be less than the centre-to-centre length of the joints. The design codes suggest an effective length factor between 0.7 and 1.0 for the in-plane buckling of the member depending upon this restraint and 1.0 for the out of plane buckling.

In the case of roof trusses, a member normally under tension due to gravity loads (dead and live loads) may experience stress reversal into compression due to dead load and wind load combination. Similarly the web members of the bridge truss may undergo stress reversal during the passage of the moving loads on the deck. Such stress reversals and the instability due to the stress reversal should be considered in design.

The design standard (IS: 800) imposes restrictions on the maximum slenderness ratio, (B/r), as given below:

<u>Member type</u>	<u>MaxB/r limit</u>
Members under compression under loads other than wind/ earthquake load	180
Tension members undergoing stress reversal due to loads other than wind load or seismic forces	180
Members normally under tension but may have to resist compression under wind load	250
Compression flange of a beam against lateral torsional buckling	300
Members designed only for tension even though they may experience stress reversal	350

Members always under tension (unless pre-tensioned to avoid sag) 400

These limits are imposed to ensure the following:

- Too slender a member is avoided which may be damaged during transportation and erection
- Members do not sag excessively under self-weight during service causing excessive deflection in truss.
- Compression members do not sag greater than $1/1000^{\text{th}}$ of their length, which is beyond the imperfection limit assumed in the compressive strength calculation.

It is a common practice to specify a minimum angle size of 50 X 50 X 6 in the case of roof trusses.

7.0 ECONOMY OF TRUSSES

As already discussed trusses consume a lot less material compared to beams to span the same length and transfer moderate to heavy loads. However, the labour requirement for fabrication and erection of trusses is higher and hence the relative economy is dictated by different factors. In India these considerations are likely to favour the trusses even more because of the lower labour cost. In order to fully utilize the economy of the trusses the designers should ascertain the following:

- Method of fabrication and erection to be followed, facility for shop fabrication available, transportation restrictions, field assembly facilities.
- Preferred practices and past experience.
- Availability of materials and sections to be used in fabrication.
- Erection technique to be followed and erection stresses.
- Method of connection preferred by the contractor and client (bolting, welding or riveting).
- Choice of as rolled or fabricated sections.
- Simple design with maximum repetition and minimum inventory of material.

8.0 COMPOSITE TRUSSES

Trusses are efficient structural systems, since the members experience essentially axial forces and hence the materials are fully utilized. Steel as a structural material is equally strong both in tension and compression and hence steel trusses are more efficient. They tend to be economical to support loads over larger span lengths. However, the members in the compression chord of the simply supported steel truss (top chord) may prematurely buckle before the stresses reach the material strength. In this context the concrete slab acting in composite with the truss compression chord becomes useful (Fig. 6).

A reinforced concrete or composite deck floor is required in any case in building and other structures to provide a flat surface. Using it as a part of the compression member in truss system could be an economical proposition. Concrete has a lower strength compared with steel and hence requires larger cross section to sustain a given

compression. Consequently, the concrete floor slab used as a part of the compression chord of the truss is less vulnerable to buckling failure. Further, concrete can more economically carry compression, whereas it is very weak in tension. In a composite truss system the relative merits of steel and concrete as construction materials are fully exploited. It is one of the most economical systems in longer span flooring construction. Thus composite truss systems are structurally efficient and economical.

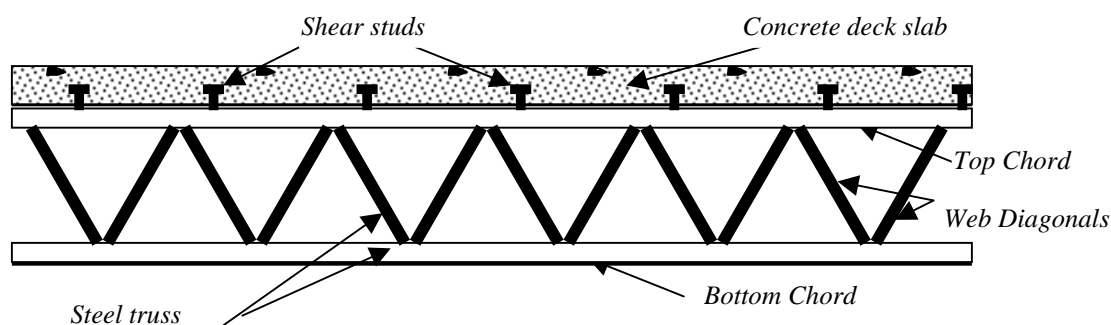

Fig. 6 Composite Truss

In multi-storey buildings, the composite truss systems also reduce the total height of the building, by accommodating the services (heating, ventilation, lighting and telecommunication ducts) within the depth of the truss, thus integrating structural, mechanical and electrical systems within in the floor space. This minimises the inter-floor height. Considering functional and structural efficiency and economy, it is only natural that composite steel-concrete trusses are a popular choice for long span and high-rise construction.

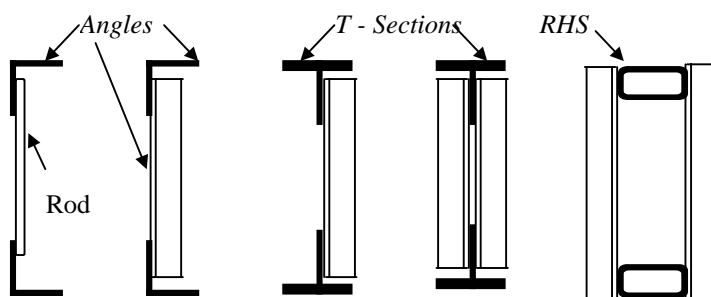

Fig. 7 Types of Truss Members

The composite truss usually consists of a parallel chord Warren truss, designed to resist, the superimposed gravity load in conjunction with the reinforced composite concrete deck slab attached to the truss through shear connectors (Fig. 6). The top and bottom chords of the truss may be made of angles, T sections or rolled steel structural tubes (Fig. 7). The web members, arranged in a Warren truss form, may be made of steel rods, single angle or double angle sections, or structural tubing welded to the chord members either directly (most common) or indirectly through gussets. The end nodes of the Warren truss are usually arranged to coincide with the reaction points of the orthogonal flooring member. The shear transfer between the steel truss and the concrete deck slab is

mobilised usually using shear studs. The deck slab may consist of cast in place concrete, either over removable centering or left-in-place profiled sheeting. The profiles in the decking may run either parallel or perpendicular to the truss in the orthogonal floor system.

The application of composites in construction is a mature technology in developed countries, frequently chosen under competitive designs. Even in India, there are a few interesting applications of the composite truss construction. Many [1,2,3] have reviewed the progress of the technology since its inception.

Early applications relied essentially on the bond between concrete and steel to bring about composite action. The requirement for efficient shear transfer led to mechanical shear connectors in later applications. Angles, channels and several other proprietary shear connectors were explored. Shear studs (straight round rods with upset head) evolved as the standard, due to their ease of installation, labour reduction and cost efficiency.

The composite trusses consisting of readymade and made to order open-web joists/trusses with cast-in-place concrete slab are most common. Instead of removable shuttering, left-in-place permanent shuttering or steel profiled sheeting was subsequently used. These evolved into composite decking slabs, wherein the profiled sheeting in addition to serving as a shuttering for green concrete, also would act as tension reinforcement for hardened concrete. The shear studs are welded to the compression chord of the truss through the deck sheet, serving as a shear transfer unit both to the truss and profiled decking.

The World Trade Centre building in New York was one of the largest applications of the composite, open-web joist system. Subsequent developments used cold-formed specially shaped top chord members made of high strength steels. The profiled metal decking also provide lateral support to the compression chord member until the concrete hardened. In early 1970's competitive, efficient systems were developed with wide concrete ribs, requiring less number of shear studs. The volume of concrete in the deck was decreased and the sprayed-on fire protection requirements were also decreased through field tests.

While the earlier studies concentrated on ultimate strength evaluation, the recent studies have dealt with service load performance characteristics, such as creep and shrinkage effects of concrete on deflection, connection detailing, improving the performance of shear studs, slab crack control, member fatigue control, vibration and energy absorption characteristics, and trusses continuous over many spans.

8.1 Stud shear connectors

Stud shear connectors are commonly used to transfer shear between the steel compression strut and concrete deck slab. These studs are welded through the metal decking on to the compression chord of the truss in the case of composite deck slabs. The design of studs is treated in greater detail in the chapter on composite beams.

The stud diameter should be limited to 2.5 times the thickness of the part to which it is welded, in order to prevent the stud tearing out of the element. This could be a critical requirement in the case of composite trusses, because of the thin chord members that may be used.

8.2 Effective concrete slab

Due to shear lag, the entire width of the slab may not be fully stressed as per the simple beam theory and for the purpose of composite action an effective section of concrete is considered in stress, deflection and strength evaluation [4]. The equations for calculating the effective width of the slab is given in the chapter on composite beams.

8.3 Design considerations

8.3.1 Preliminary Design

For the preliminary design of a composite truss the following data is needed:

- The maximum bending moments and shear forces in the member
 - (a) at the construction stage (M_s , V_s),
 - (b) at the factored load acting at the limit state of collapse of the composite section (M_c , V_c).
- the concrete slab (regular or composite) sizes and
- the truss spacing.

The following are the steps in the preliminary design:

1. Decide on the depth of the truss girder.
 - The span to depth ratio of a simply supported composite truss is normally 15 to 20.
2. Develop the web member layout, usually using Warren configuration.
 - Use a slope of 30 degrees to horizontal to increase the opening and reduce the number of connections.
3. Design the top chord member.
 - Force in the top chord member at the construction load, R_t , is calculated from the corresponding moment, M_s , and the lever arm between the chord members (Fig. 8).
 - Size of the member is based on the member strength as governed by lateral buckling between the lateral supports to the top chord until the concrete hardens.
 - A minimum width of 120 mm for the top chord is usually acceptable to support the decking in a stable manner during erection.
 - Minimum of 8 mm thickness of the leg of the compression chord is required to weld the stud through the deck on to the leg.
 - Vertical leg of the member should be adequate to directly weld the web members. Otherwise gusset may be required.

- Local bending should be considered in between the nodal points in case of loading between nodes

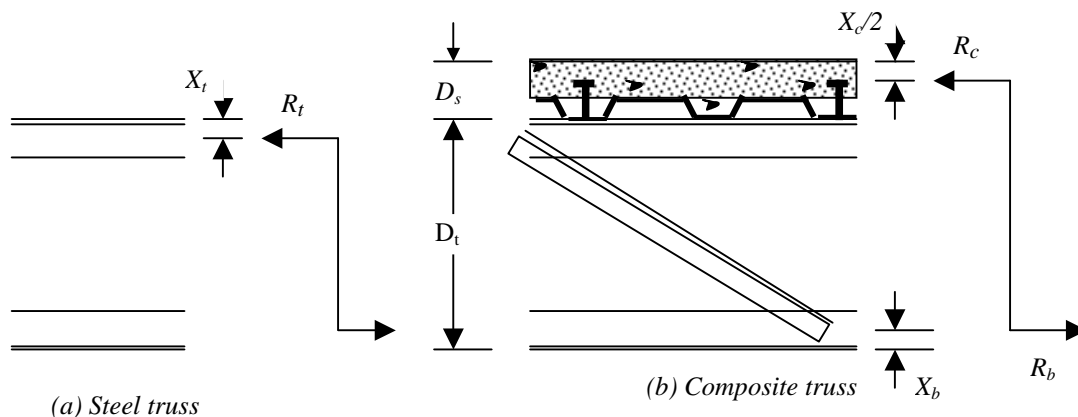

Fig. 8 Moment Capacity of Steel and Composite Trusses

- Design the bottom chord member.
 - Calculate the tension in the bottom chord, R_b , at the factored load moment using the following equation.

$$R_b = M_c(D_t + D_s - 0.5 X_c - X_b) \quad (4)$$

where $X_c = (D_s - D_p) R_b / R_c$, $D_p =$ Depth of the profile, R_b , R_t , R_c are the forces in the bottom chord, top chord of steel truss and the force in concrete slab, respectively.

- Area of the bottom chord and the bottom chord member shape may be designed based on this force, R_b , considering the yield strength of the member.
- Check the slab capacity for the compression force at the limit state of collapse.
 - The slab capacity is given by

$$R_c = 0.45 f_{ck} b_{eff} (D_s - D_p) \quad (5)$$
 where $f_{ck} =$ cube strength of concrete and b_{eff} is the effective width of the concrete slab acting integral with the truss.

- Design the web member.
 - The maximum force in the web member is calculated by setting the vertical component of the member force equal to the maximum shear force in the truss.
 - The web member is designed to carry the force considering its yield strength in tension and buckling strength in compression.

8.3.2 Detailed Analysis and Design

The composite truss thus evolved may be analysed in an exact fashion using a more accurate truss analysis following either manual or computer method. The methods of modeling for computer analysis are presented in reference 3.

The composite truss should be checked for (a) limit state at construction load, (b) limit state at service load and (c) limit state of collapse.

a) The limit state at construction load

During the construction the truss has to carry all the superimposed loads until concrete sets. The top chord of the truss at this stage can fail either by reaching the material strength or lateral buckling strength, the lateral buckling being the more vulnerable mode of failure. In order to improve the lateral buckling strength, the top chord may be laterally braced in between supports either temporarily or permanently. In case the truss supports composite deck slab, once the profiled metal decking is attached to the top chord by the welding of studs to the top chord through the deck metal, it may be assumed to provide adequate lateral support to the compression chord.

Until the green concrete hardens, the steel section alone has to support all the dead weight and construction live load. Hence, the failure mode of the truss can be due to yielding / buckling (lateral or in-plane) of the top chord in the plane of truss due to compression, failure of the web member by yielding / buckling. In order to reduce the forces in members during this stage, propping of the truss from below at one or more points can be done.

b) The limit state at service load

Strength: Before the concrete hardens, the members of the truss experience forces due to its self-weight and the weight of composite deck profile, green concrete and reinforcements. The composite truss resists the loads applied after the concrete hardens (the super imposed dead load, and floor live loads). These loads cause axial forces in all the members due to truss action. Furthermore, the top chord is subjected to bending moment due to UDL / concentrated load between the nodes of the truss, which is resisted by the steel alone before concrete hardens and by the composite section after the concrete hardens.

In the allowable stress method, the members have to be checked for stresses at this service load to ensure adequate factor of safety in addition to deflection. If the construction is shored, then the stresses have to be calculated for the entire dead load acting on the composite section. If the construction is un-shored, the stresses due to the self weight including green concrete, sustained by steel section acting alone, have to be superposed on stresses due to super imposed dead load and live load acting on the composite member. In the case of cyclically loaded composite trusses, as in composite bridges, the stress range at the service load has to be calculated and checked for fatigue. Further, deflection at this service load is to be checked, as discussed in the following section.

Deflection: The deflection of the steel truss alone due to construction load has to be checked before concrete hardens and that of the composite truss for the full dead and service live load as given below.

At the time of concreting, the deflection of the truss system could cause ponding of concrete leading to a larger slab thickness while leveling concrete. In order to overcome this, pre-camber is specified for the truss, particularly in the unshored construction. If the calculated deflection of the steel truss alone under the construction load (dead load and construction live load) is less than 20mm no cambering is necessary. If the deflection is greater than 20mm camber is provided in the top chord of the truss to an extent slightly less than the calculated deflection. This is to account for moment restraint provide by even simple connections at the ends of the truss, the stiffness of the supporting member, non-hinged nature of the truss joints, all of which reduce the actual deflection to a value below the theoretical value.

The deflection under the full dead load and live load is calculated, considering the composite action under super imposed dead load and live load and simple steel truss action for dead load until the concrete hardens after accounting for camber given in the top chord. The deflection calculation should include the instantaneous deflection, creep effect and shrinkage effect. The shrinkage effect can be accounted for by calculating the deflection due to net restrained shrinkage strain of around 200 microns at the slab level. The creep deflection is calculated for the sustained load corresponding to the total dead load and sustained live load in the case of shored construction and only superimposed dead load and sustained live load in the case of unshored construction. For this purpose, the transformed area of concrete is calculated using the modular ratio corresponding to the creep modulus of concrete. The instantaneous deflection is calculated using the transformed section arrived at using the elastic modular ratio.

Span to depth ratio limitation can be effective to prevent excessive deflection and vibration under moving loads. The span to depth ratio of 20 for steel truss alone and 25 for the composite truss would be usually adequate for buildings. Slightly reduced values would be appropriate (15 to 20 respectively) in bridge trusses. The vibration control could be achieved by ensuring that any applied vibration frequency of any machinery is not close to the natural frequency of the composite flooring and ensuring the natural frequency is above 4 cycles per second. There is also a strong correlation between deflection control and vibration control, so much so that usually strict deflection control under loads would also ensure satisfactory vibration performance.

c) The limit state of collapse

At the limit state of collapse the sequence of loading and the corresponding non-composite / composite member behaviour is immaterial. The composite member resists the total factored load. The different members of the composite truss are checked for their limit state of collapse under factored loads as given below:

- Ultimate tensile strength of bottom chord as governed by yield strength of the gross area or ultimate strength of net effective area.
- Ultimate tensile / compressive strength of the web members, depending upon the type of axial force under factored loading.
- Ultimate strength of the composite compression chord under combined bending (at nodes and in between nodes) due to load in between nodes and compression.

8.3.3 Design of Studs

The shear studs within a panel of a truss have to transfer the shear between the slab and top chord. This is due to overall composite truss action and the additional shear due to the bending of top chord between panel points, caused by the UDL/concentrated load between the panel points of the truss.

In the composite truss action, the forces in the composite top chord would be due to full load in the case of shored construction and due to super imposed dead and live load only in the case of un-shored construction. The unbalanced component of the compressive load on the concrete slab (ΔC_t) causes shear in the studs. The bending moments at the nodal point are calculated, only due to super imposed dead and live load. Due to this bending, the shear in the stud over half the span is calculated as $(T_{sb} + C_{sb})$ as shown in Fig. 9. The studs have to resist these combined forces due to local bending between nodes and overall truss action, at ultimate load, assuming the shear to be uniformly shared by the studs in the

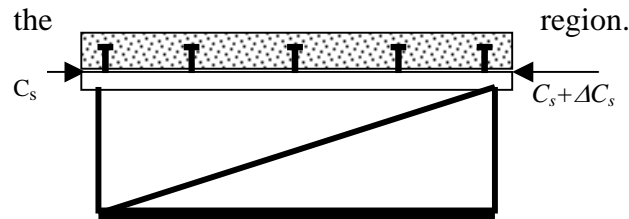

(a) Due to Composite Truss



(b) Due to Composite Bending of Top Chord

8.3.4 Partial Shear Connection

In the elastic range, the **Fig. 9 Forces in Studs at Limit State of** actual shear force in shear connections over the span length varies according to the variation of the shear diagram. At the ultimate load, redistribution of the shear force among shear connectors takes place due to the ductility of stud shear connector and the slip between the steel and concrete. Hence, the shear in the shear connectors in a shear span is assumed as uniform, at the ultimate load.

The shear connectors in bridges are spaced according to the elastic theory to avoid stress concentration and fatigue failure at service load and a limit of 55% of the shear stud

capacity is imposed at the service load limit state. In buildings the shear connectors are spaced uniformly over the length.

The number of shear connectors as required by the elastic design may be very high. In such cases partial shear connection (50 – 70% of full shear connection) may be used. In such a case, the shear capacity of the shear connections and hence the effectiveness of the concrete in compression is to be reduced accordingly, some times leading to increase in the size of steel chord members. The use of partial shear connection also leads to slight increase in the service load deflection. However, considering the large area of concrete in compression, partial shear connections usually do not cause any appreciable changes in the final design.

8.3.5 Concrete Cracking

The deck slab may have a tendency to crack, especially at the interior supports of continuous composite beams. In order to minimise the cracking, the steel reinforcement is employed in the direction perpendicular to the potential cracks at supports.

8.3.6 Practical Considerations

- Ductile failure can be obtained, provided the design is governed by the ultimate strength of the tension chord member and the strength of top chord, web and stud connectors are large enough to preclude their premature failure.
- To facilitate stud welding, the top chord made of T or tubular section with a minimum width of 50mm is preferred, instead of smaller single or double angles.

8.4 Cost implications

The steel weight savings, the change of ratio in labour content to weight of the structure and the reduction in time for the completion of the work are three important factors that contribute to the cost reduction of the composite truss design. The project analysis division of the Canadian Institute of Steel Construction carried out a review of a number of design examples, covering steel framed buildings with braced steel core, gravity steel framing with concrete core(s). The total building costs including the deck slab and fire protection were considered. The results are tabulated in ref [2]. The summary of the findings of this study is as follows:

- The material savings in composite construction can be as high as 20 to 40 percent compared to non-composite steel construction, in the case of girder flooring. Further material savings of about 20 percent is possible if composite trusses are used instead of composite girders.
- The cost saving of composite girders is smaller (between 15 and 30%) compared to weight savings, due to the cost of studs and additional labour associated with composite construction. Further, cost savings of about 15% is possible by using composite trusses instead of composite girders.

In the case of composite construction in India, the difference between the percentage of weight saving and cost saving should be lesser due to the lower labour cost. Consequently the composite construction, particularly use of composite trusses in long span structure, could mean considerable economy as realised in U.K., New Zealand, South Africa, Australia and Singapore, in the past two decades.

9.0 SUMMARY

In this chapter, initially the behaviour and design of steel trusses were dealt with. Important aspects of truss systems such as the systems, their economy, their connections were discussed. Then the use of steel truss and reinforced concrete slab acting together as a composite truss was discussed in this chapter. After a brief introduction, the historical evolution of the system was discussed. The background information for the design of the composite trusses was presented. The economy of the system, particularly in the Indian context was evaluated. The discussions indicate that there is great potential for the use of the system in the Indian context.

10.0 REFERENCES

1. Anon, "Design of Composite Trusses", Steel Construction Institute", Ascot, 1992.
2. Anon " Constructional Steel Design: An International Guide", Elsevier, London, 1993.
3. Chien, E.Y.L. and Ritchie, J.K, "Composite Floor Systems – A Mature Design Option", Journal of Constructional Steel Research, V. 25, 1993, pp107-139.
4. Vallenilla, C.R., and Bjorhovde, R., "Effective Width Criteria for Composite Beams", Engineering Journal, AISC, Fourth Quarter, 1985, pp. 169-175.

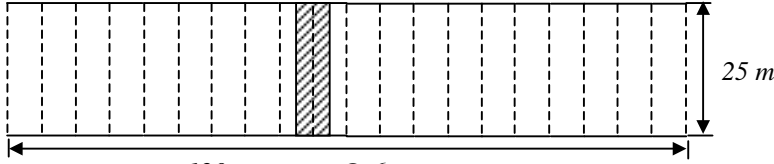
<h1>Structural Steel Design Project</h1> <h2>Calculation Sheet</h2>	Job No:	Sheet 1 of 13	Rev
	Job Title: <i>ROOF TRUSS</i>		
	<i>Worked Example - 1</i>		
		Made by SSSR	Date 9-2-2000
	Checked by PU	Date 16-08-00	
<p>PROBLEM 1:</p> <p><i>Design a roof truss for an industrial building with 25 m span and 120 m long. The roofing is galvanized iron sheeting. The basic wind speed is 50 m/s and terrain is open industrial area and building is class A building. The building clear height at the eaves is 9 m.</i></p> <p>Structural form:</p> <p><i>For the purpose of this design example a trapezoidal truss is adopted with a roof slope of 1 to 5 and end depth of 1 m. For this span range the trapezoidal trusses would be normally efficient and economical.</i></p> <p><i>Economical span to depth ratio is around 10.</i></p> <p><i>Then, Span/depth = $25/3.5 = 7.1$</i></p> <p><i>Hence, depth is acceptable.</i></p> <p>Truss spacing:</p> <p><i>Truss spacing should be in the region of $1/4^{\text{th}}$ to $1/5^{\text{th}}$ of the span length.</i></p> <p><i>For 6 m spacing,</i></p> <p><i>Spacing/span = $6/25 = 1/4.17$ (acceptable)</i></p> <p><i>Then, number of bays = $120/6 = 20$</i></p> <div style="text-align: center;">  <p><i>120 m, trusses @ 6 m</i></p> <p><i>25 m</i></p> <p><i>Plan</i></p> </div>			

<h1>Structural Steel Design Project</h1> <h2>Calculation Sheet</h2>	Job No:	Sheet 2 of 13	Rev																																	
	Job Title: <i>ROOF TRUSS</i>																																			
	<i>Worked Example - 1</i>																																			
		Made by SSSR	Date 9-2-2000																																	
	Checked by PU	Date 16-08-00																																		
<p>Truss configuration:</p>																																				
<p>Loading:</p> <p style="text-align: center;">kN/m^2</p> <p>Dead load:</p> <table style="width: 100%; border-collapse: collapse;"> <tr> <td style="width: 30%;">GI sheeting\</td> <td style="width: 30%;"></td> <td style="width: 40%; text-align: right;">= 0.085</td> </tr> <tr> <td>Fixings</td> <td></td> <td style="text-align: right;">= 0.025</td> </tr> <tr> <td>Services</td> <td></td> <td style="text-align: right;"><u>= 0.100</u></td> </tr> <tr> <td>Total load</td> <td></td> <td style="text-align: right;">= 0.210</td> </tr> </table> <p>For 6 m bays,</p> <table style="width: 100%; border-collapse: collapse;"> <tr> <td style="width: 30%;">Roof dead load</td> <td style="width: 30%;"></td> <td style="width: 40%; text-align: right;">= 0.21 * 25 * 6 = 31.5 kN</td> </tr> <tr> <td>Weight of purlin</td> <td></td> <td style="text-align: right;">= 0.07 * 6 * 25 = 10.5 kN</td> </tr> <tr> <td colspan="3">(Assuming 70 N/m²)</td> </tr> <tr> <td>* Self-weight of truss</td> <td></td> <td style="text-align: right;"><u>= 0.133 * 6 * 25 = 20.0 kN</u></td> </tr> <tr> <td>Total dead load</td> <td></td> <td style="text-align: right;">= 62.0 kN</td> </tr> </table> <p>* [For welded sheeted roof trusses, the self-weight is given approximately by</p> <table style="width: 100%; border-collapse: collapse;"> <tr> <td style="width: 30%; text-align: center;">w</td> <td style="width: 30%;"></td> <td style="width: 40%; text-align: right;">= (1/100) (5.37 + 0.053A) kN/m²</td> </tr> <tr> <td></td> <td></td> <td style="text-align: right;">= (5.37 + 0.053 * 6 * 25) = 0.133 kN/m²</td> </tr> </table>				GI sheeting\		= 0.085	Fixings		= 0.025	Services		<u>= 0.100</u>	Total load		= 0.210	Roof dead load		= 0.21 * 25 * 6 = 31.5 kN	Weight of purlin		= 0.07 * 6 * 25 = 10.5 kN	(Assuming 70 N/m ²)			* Self-weight of truss		<u>= 0.133 * 6 * 25 = 20.0 kN</u>	Total dead load		= 62.0 kN	w		= (1/100) (5.37 + 0.053A) kN/m ²			= (5.37 + 0.053 * 6 * 25) = 0.133 kN/m ²
GI sheeting\		= 0.085																																		
Fixings		= 0.025																																		
Services		<u>= 0.100</u>																																		
Total load		= 0.210																																		
Roof dead load		= 0.21 * 25 * 6 = 31.5 kN																																		
Weight of purlin		= 0.07 * 6 * 25 = 10.5 kN																																		
(Assuming 70 N/m ²)																																				
* Self-weight of truss		<u>= 0.133 * 6 * 25 = 20.0 kN</u>																																		
Total dead load		= 62.0 kN																																		
w		= (1/100) (5.37 + 0.053A) kN/m ²																																		
		= (5.37 + 0.053 * 6 * 25) = 0.133 kN/m ²																																		

<h1>Structural Steel Design Project</h1> <h2>Calculation Sheet</h2>	Job No:	Sheet 3 of 13	Rev
	Job Title: <i>ROOF TRUSS</i>		
	<i>Worked Example - 1</i>		
		Made by SSSR	Date 9-2-2000
	Checked by PU	Date 16-08-00	
<p>Dead Loads</p> <p><i>Intermediate nodal dead load (W_1) = 62.0/20 = 3.1 kN</i></p> <p><i>Dead load at end nodes ($W_1/2$) = 3.1/2 = 1.55 kN</i></p> <p><i>(Acts vertically downwards at all nodes)</i></p> <p>Wind load (IS: 875-1987):</p> <p><i>Basic wind speed = 50 m/s</i></p> <p><i>Wind load F on a roof truss by static wind method is given by</i></p> $F = (C_{pe} - C_{pi}) * A * p_d$ <p><i>where, C_{pe}, C_{pi} are force co-efficient for exterior and interior of the building.</i></p> <p>Value of C_{pi}:</p> <p><i>Assume wall openings between 5-20% of wall area.</i></p> <p><i>Then, $C_{pi} = \pm 0.5$</i></p> <p>Value of C_{pe}:</p> <p><i>Roof angle = $\alpha = \tan^{-1} \frac{1}{5} = 11.3^\circ$</i></p> <p><i>Height of the building to eaves, $h = 9$ m</i></p> <p><i>Lesser dimension of the building in plan, $w = 25$ m</i></p> <p><i>Building height to width ratio is given by,</i></p> $\frac{h}{w} = \frac{9}{25} = 0.36 < 0.5$			

<h1>Structural Steel Design Project</h1> <h2>Calculation Sheet</h2>	Job No:	Sheet 4 of 13	Rev
	Job Title: <i>ROOF TRUSS</i>		
	<i>Worked Example - 1</i>		
	Made by <i>SSSR</i>	Date 9-2-2000	
Checked by <i>PU</i>	Date 16-08-00		

h/w	Roof angle	Wind angle		Wind angle	
	α	Windward side	Leeward side	Windward side	Leeward side
0.36	10^0	- 1.2	- 0.4	- 0.8	- 0.8
	20^0	- 0.4	- 0.4	- 0.7	- 0.7
	<i>Here, $\alpha = 11.3^0$, then by interpolation we get</i>				
	11.3^0	- 1.1	- 0.4	- 0.79	- 0.79

Risk Co-efficient, $k_1 = 1.0$

(Assuming the industrial building as general building and its probable life about 50 years)

Terrain, height, structure size factor, k_2 :

Roof elevation - 9 m to 12.5 m.

Height (m) Terrain category and class of building

10	0.91
15	0.97

For 12.5 m, $k_2 = 0.94$

Assume, topography factor = $k_3 = 1.0$

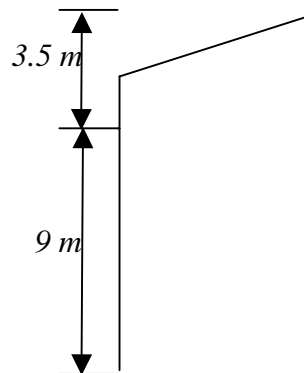

<h1>Structural Steel</h1>	Job No:	Sheet 5 of 13	Rev
	Job Title: <i>ROOF TRUSS</i>		

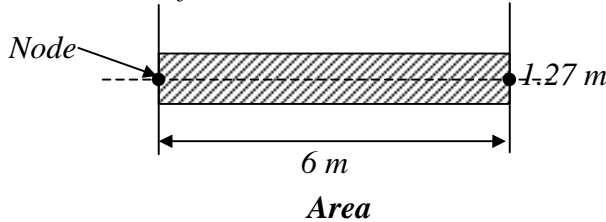
Design Project	<i>Worked Example - 1</i>		
	Calculation Sheet	Made by	SSSR
Checked by		PU	Date 16-08-00
<p>Wind pressure:</p> <p>Total height of the building = 12.5 m</p> <p>Basic wind speed, v_b = 50 m/s</p> <p>Design wind speed v_z is given by,</p> $v_z = k_1 * k_2 * k_3 * v_b.$ <p>$k_1 = 1.0$ $k_2 = 0.94$ $k_3 = 1.0$</p> $v_z = 0.94 * 1 * 1 * 50 = 47 \text{ m/s}$ <p>Design wind pressure (p_d) = $0.6 v_z^2 = 0.6 * (47)^2$ $= 1325 \text{ N/m}^2$ $= 1.325 \text{ kN/m}^2$</p> <p>Tributary area for each node of the truss:</p> <p>Length of each panel along sloping roof</p> $= \frac{1.25}{\cos 11.3^\circ} = 1.27 \text{ m} \leq 1.4 \text{ m}$ <p>Spacing of trusses = 6m</p> <p>Tributary area for each node of the truss = $6 * 1.27 = 7.62 \text{ m}^2$</p> 			
Structural Steel	Job No:	Sheet 6 of 13	Rev
	Job Title: ROOF TRUSS		
	<i>Worked Example - 1</i>		

Design Project		Made by <i>SSSR</i>	Date 9-2-2000
	Calculation Sheet		Checked by <i>PU</i>

Wind load on roof truss:

Wind angle	Pressure co-efficient		$(C_{pe}-C_{pi})$		$A p_d$ (kN)	Wind load F (kN)		
	C_{pe}		Wind ward	Lee ward		Wind ward	Lee ward	
	Wind ward	Lee ward						C_{pi}
0°	-1.10	-0.4	0.5	-1.6	-0.9	10.1	-16.2	-9.1
			-0.5	-0.6	0.1	10.1	-6.1	1.0
90°	-0.79	-0.79	0.5	-1.29	-1.29	10.1	-13.0	-13.0
			-0.5	-0.29	-0.29	10.1	-2.9	-2.9

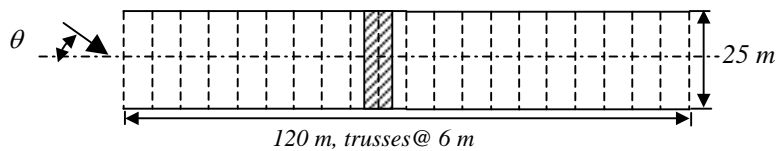

Maximum $C_{pe} - C_{pi}$:

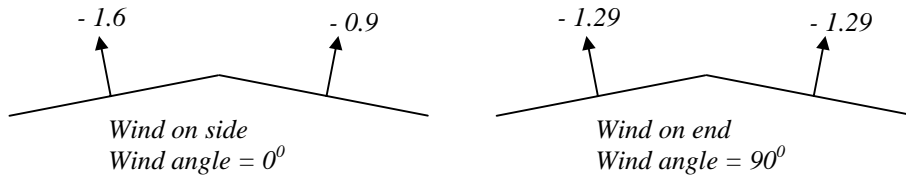

Critical wind loads to be considered for analysis:

Wind angle	Wind ward side (W_3)		Lee ward side (W_4)	
	Intermediate nodes W_3	End and apex nodes $W_3/2$	Intermediate nodes W_4	End and apex nodes $W_4/2$
0°	-16.2	-8.1	-9.1	-4.55
90°	-13.0	-6.5	-13.0	-6.5

**Loads in kN*

Structural Steel	Job No:	Sheet 7 of 13	Rev
	Job Title: <i>ROOF TRUSS</i>		
	Worked Example - 1		

Design Project	Made by SSSR	Date 9-2-2000
	Checked by PU	Date 16-08-00
Calculation Sheet		

Imposed load:

Live load = 0.35 kN/m^2 [From IS: 875 – 1964]

Load at intermediate nodes, $W_2 = 0.35 * 6 * 1.25$
 $= 2.63 \text{ kN}$

Load at intermediate nodes, $W_2/2 = 1.32 \text{ kN}$

(Acts vertically downwards)

Loading pattern:

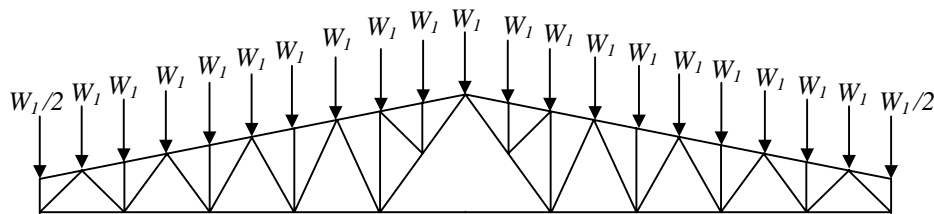

(a) **Dead load**

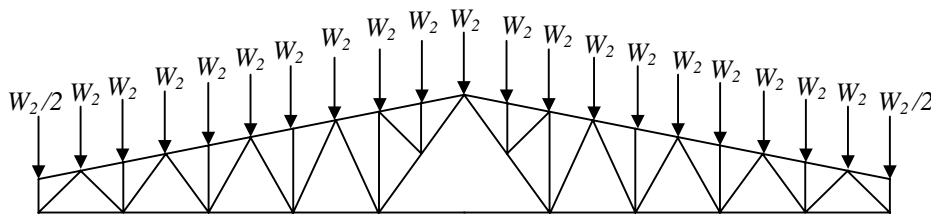

(b) **Live load**

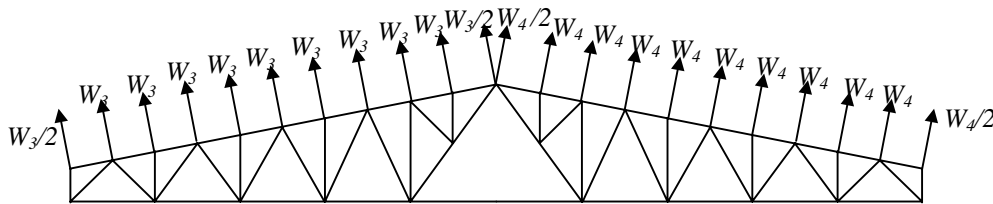

(c) **Wind load**

Structural Steel	Job No:	Sheet 8 of 13	Rev
	Job Title: <i>ROOF TRUSS</i>		
	Worked Example - 1		

Design Project			Made by SSSR	Date 9-2-2000																																																																																																																																																																									
	Calculation Sheet		Checked by PU	Date 16-08-00																																																																																																																																																																									
Forces in the members:																																																																																																																																																																													
<p>The truss has been modeled as a pin jointed plane truss and analysed using SAP90 software. The analysis results are tabulated below. [See truss configuration for member ID]</p>																																																																																																																																																																													
<table border="1"> <thead> <tr> <th rowspan="2">Member</th> <th colspan="4">Member Forces (kN)</th> </tr> <tr> <th>Dead load</th> <th>Live load</th> <th>Wind on side</th> <th>Wind on end</th> </tr> </thead> <tbody> <tr><td>A-B</td><td>0</td><td>0</td><td>1.6</td><td>1.3</td></tr> <tr><td>B-C</td><td>-47.4</td><td>-40.2</td><td>214.9</td><td>172.5</td></tr> <tr><td>C-D</td><td>-47.4</td><td>-40.2</td><td>218.1</td><td>175.0</td></tr> <tr><td>D-E</td><td>-63.2</td><td>-53.6</td><td>284.3</td><td>228.1</td></tr> <tr><td>E-F</td><td>-63.2</td><td>-53.6</td><td>287.5</td><td>230.7</td></tr> <tr><td>F-G</td><td>-66.4</td><td>-56.3</td><td>294.8</td><td>236.6</td></tr> <tr><td>G-H</td><td>-66.4</td><td>-56.3</td><td>298</td><td>239.1</td></tr> <tr><td>H-I</td><td>-63.2</td><td>-53.6</td><td>276</td><td>221.5</td></tr> <tr><td>I-J</td><td>-64.5</td><td>-54.8</td><td>286.2</td><td>229.7</td></tr> <tr><td>J-K</td><td>-64.5</td><td>-54.8</td><td>289.4</td><td>232.2</td></tr> <tr><td>a-A</td><td>-1.6</td><td>-1.3</td><td>8.3</td><td>6.7</td></tr> <tr><td>a-B</td><td>-41.6</td><td>-35.3</td><td>186.5</td><td>149.7</td></tr> <tr><td>a-b</td><td>29.5</td><td>25</td><td>-131.8</td><td>-105.8</td></tr> <tr><td>b-B</td><td>24.1</td><td>20.5</td><td>-104.8</td><td>-84.1</td></tr> <tr><td>b-C</td><td>-3.1</td><td>-2.6</td><td>16.5</td><td>13.2</td></tr> <tr><td>b-D</td><td>-17.1</td><td>-14.5</td><td>70.8</td><td>56.8</td></tr> <tr><td>b-c</td><td>56.5</td><td>47.9</td><td>-247.1</td><td>-198.3</td></tr> <tr><td>c-D</td><td>9.5</td><td>8.1</td><td>-35.4</td><td>-28.4</td></tr> <tr><td>c-E</td><td>-3.1</td><td>-2.6</td><td>16.5</td><td>13.2</td></tr> <tr><td>c-F</td><td>-5.3</td><td>-4.5</td><td>14</td><td>11.2</td></tr> <tr><td>c-d</td><td>64.6</td><td>54.8</td><td>-274.5</td><td>-220.3</td></tr> <tr><td>d-F</td><td>1</td><td>0.9</td><td>5.8</td><td>4.7</td></tr> <tr><td>d-G</td><td>-3.1</td><td>-2.63</td><td>16.5</td><td>13.2</td></tr> <tr><td>d-H</td><td>2.4</td><td>2</td><td>-23.7</td><td>-19.0</td></tr> <tr><td>d-e</td><td>64.1</td><td>54.4</td><td>-262</td><td>-210.2</td></tr> <tr><td>e-H</td><td>-5.1</td><td>-4.3</td><td>36.4</td><td>29.2</td></tr> <tr><td>e-I</td><td>-4.6</td><td>-3.9</td><td>24.8</td><td>19.9</td></tr> <tr><td>e-f</td><td>11.4</td><td>9.7</td><td>-71.1</td><td>-57.1</td></tr> <tr><td>e-h</td><td>55.4</td><td>47</td><td>-205.5</td><td>-164.9</td></tr> <tr><td>f-I</td><td>1.8</td><td>1.6</td><td>-9.7</td><td>-7.8</td></tr> <tr><td>f-J</td><td>-3.1</td><td>-2.6</td><td>16.5</td><td>13.2</td></tr> <tr><td>f-K</td><td>13.6</td><td>11.6</td><td>-83</td><td>-66.6</td></tr> </tbody> </table>					Member	Member Forces (kN)				Dead load	Live load	Wind on side	Wind on end	A-B	0	0	1.6	1.3	B-C	-47.4	-40.2	214.9	172.5	C-D	-47.4	-40.2	218.1	175.0	D-E	-63.2	-53.6	284.3	228.1	E-F	-63.2	-53.6	287.5	230.7	F-G	-66.4	-56.3	294.8	236.6	G-H	-66.4	-56.3	298	239.1	H-I	-63.2	-53.6	276	221.5	I-J	-64.5	-54.8	286.2	229.7	J-K	-64.5	-54.8	289.4	232.2	a-A	-1.6	-1.3	8.3	6.7	a-B	-41.6	-35.3	186.5	149.7	a-b	29.5	25	-131.8	-105.8	b-B	24.1	20.5	-104.8	-84.1	b-C	-3.1	-2.6	16.5	13.2	b-D	-17.1	-14.5	70.8	56.8	b-c	56.5	47.9	-247.1	-198.3	c-D	9.5	8.1	-35.4	-28.4	c-E	-3.1	-2.6	16.5	13.2	c-F	-5.3	-4.5	14	11.2	c-d	64.6	54.8	-274.5	-220.3	d-F	1	0.9	5.8	4.7	d-G	-3.1	-2.63	16.5	13.2	d-H	2.4	2	-23.7	-19.0	d-e	64.1	54.4	-262	-210.2	e-H	-5.1	-4.3	36.4	29.2	e-I	-4.6	-3.9	24.8	19.9	e-f	11.4	9.7	-71.1	-57.1	e-h	55.4	47	-205.5	-164.9	f-I	1.8	1.6	-9.7	-7.8	f-J	-3.1	-2.6	16.5	13.2	f-K	13.6	11.6	-83	-66.6
Member	Member Forces (kN)																																																																																																																																																																												
	Dead load	Live load	Wind on side	Wind on end																																																																																																																																																																									
A-B	0	0	1.6	1.3																																																																																																																																																																									
B-C	-47.4	-40.2	214.9	172.5																																																																																																																																																																									
C-D	-47.4	-40.2	218.1	175.0																																																																																																																																																																									
D-E	-63.2	-53.6	284.3	228.1																																																																																																																																																																									
E-F	-63.2	-53.6	287.5	230.7																																																																																																																																																																									
F-G	-66.4	-56.3	294.8	236.6																																																																																																																																																																									
G-H	-66.4	-56.3	298	239.1																																																																																																																																																																									
H-I	-63.2	-53.6	276	221.5																																																																																																																																																																									
I-J	-64.5	-54.8	286.2	229.7																																																																																																																																																																									
J-K	-64.5	-54.8	289.4	232.2																																																																																																																																																																									
a-A	-1.6	-1.3	8.3	6.7																																																																																																																																																																									
a-B	-41.6	-35.3	186.5	149.7																																																																																																																																																																									
a-b	29.5	25	-131.8	-105.8																																																																																																																																																																									
b-B	24.1	20.5	-104.8	-84.1																																																																																																																																																																									
b-C	-3.1	-2.6	16.5	13.2																																																																																																																																																																									
b-D	-17.1	-14.5	70.8	56.8																																																																																																																																																																									
b-c	56.5	47.9	-247.1	-198.3																																																																																																																																																																									
c-D	9.5	8.1	-35.4	-28.4																																																																																																																																																																									
c-E	-3.1	-2.6	16.5	13.2																																																																																																																																																																									
c-F	-5.3	-4.5	14	11.2																																																																																																																																																																									
c-d	64.6	54.8	-274.5	-220.3																																																																																																																																																																									
d-F	1	0.9	5.8	4.7																																																																																																																																																																									
d-G	-3.1	-2.63	16.5	13.2																																																																																																																																																																									
d-H	2.4	2	-23.7	-19.0																																																																																																																																																																									
d-e	64.1	54.4	-262	-210.2																																																																																																																																																																									
e-H	-5.1	-4.3	36.4	29.2																																																																																																																																																																									
e-I	-4.6	-3.9	24.8	19.9																																																																																																																																																																									
e-f	11.4	9.7	-71.1	-57.1																																																																																																																																																																									
e-h	55.4	47	-205.5	-164.9																																																																																																																																																																									
f-I	1.8	1.6	-9.7	-7.8																																																																																																																																																																									
f-J	-3.1	-2.6	16.5	13.2																																																																																																																																																																									
f-K	13.6	11.6	-83	-66.6																																																																																																																																																																									
Structural Steel	Job No:	Sheet 9 of 13	Rev																																																																																																																																																																										
	Job Title: ROOF TRUSS																																																																																																																																																																												
	Worked Example - 1																																																																																																																																																																												

Design Project	Made by <i>SSSR</i>	Date <i>9-2-2000</i>
	Checked by <i>PU</i>	Date <i>16-08-00</i>
Calculation Sheet		
<p>Load factors and combinations: <i>For dead + imposed</i> $1.5*DL + 1.5*LL$</p> <p><i>For dead + wind</i> $1.5*DL + 1.5*LL$ <i>or</i> $0.9*DL + 1.5*LL$</p> <p><i>For dead + imposed + wind</i> <i>Not critical as wind loads act in opposite direction to dead and imposed loads</i></p> <p>Member Forces under Factored loads in kN:</p>		
Structural Steel	Job No:	Sheet <i>10 of 13</i>
	Rev	
	Job Title: <i>ROOF TRUSS</i>	
Worked Example - 1		

Design Project		Made by <i>SSSR</i>	Date <i>9-2-2000</i>
		Checked by	Date <i>16-08-00</i>

<i>Member</i>	<i>Member Design Forces (kN)</i>	
	<i>DL + WL</i>	<i>DL + LL</i>
<i>A-B</i>	2.4	0
<i>B-C</i>	251.25	-131.4
<i>C-D</i>	256.05	-131.4
<i>D-E</i>	331.65	-175.2
<i>E-F</i>	336.45	-175.2
<i>F-G</i>	342.6	-184.05
<i>G-H</i>	347.4	-184.05
<i>H-I</i>	319.2	-175.2
<i>I-J</i>	332.55	-178.95
<i>J-K</i>	337.35	-178.95
<i>a-A</i>	10.05	-4.35
<i>a-B</i>	217.35	-115.35
<i>a-b</i>	-153.45	81.75

<i>Member</i>	<i>DL + WL</i>	<i>DL + LL</i>
<i>b-B</i>	-121.05	66.9
<i>b-C</i>	20.1	-8.55
<i>b-D</i>	80.55	-47.4
<i>b-c</i>	-285.9	156.6
<i>c-D</i>	-38.85	26.4
<i>c-E</i>	20.1	-8.55
<i>c-F</i>	13.05	-14.7
<i>c-d</i>	-314.85	179.1
<i>d-F</i>	10.2	2.85
<i>d-G</i>	20.1	-8.595
<i>d-H</i>	-31.95	6.6
<i>d-e</i>	-296.85	177.75
<i>e-H</i>	46.95	-14.1
<i>e-I</i>	30.3	-12.75
<i>e-f</i>	-89.55	31.65
<i>e-h</i>	-225.15	153.6
<i>f-I</i>	-11.85	5.1
<i>f-J</i>	20.1	-8.55
<i>f-K</i>	-104.1	37.8

Top Chord Design:(G-H)

Maximum compressive force = 174.1 kN

Maximum tensile force = 357.4 kN

Trying ISNT 150 X 150 X 10 mm @ 0.228 kN/m

Section Properties:

Area of Cross section = $A_t = 2908 \text{ mm}^2$

Width of Section = $2B = 150 \text{ mm}$

Thickness of flange = $T = 10 \text{ mm}$

Structural Steel Design Project	Job No:	Sheet <i>11 of 13</i>	Rev
	Job Title: <i>ROOF TRUSS</i>		
	<i>Worked Example - 1</i>		
		Made by <i>SSSR</i>	Date <i>9-2-2000</i>
		Checked by <i>PU</i>	Date <i>16-08-00</i>
Calculation Sheet			

Section classification:

$$\varepsilon = (250/f_y)^{0.5} = (250/250)^{1/2} = 1.0$$

Flange:

$$B/T = 75/10 = 7.5 < 8.9\varepsilon \quad (\text{Flange is plastic})$$

Web:

$$d/t = 140/10 = 14 [> 9.975\varepsilon \text{ and } < 19.95\varepsilon]$$

(Web is semi-compact)

As no member in the section is slender, the full section is effective and there is no need to adopt reduction factor.

$$\text{Maximum unrestrained length} = B_y = 3810 \text{ mm}$$

(Assuming every two alternative nodes are restrained)

$$r_{yy} = 30.3 \text{ mm}$$

$$\lambda_y = 3810/30.3 = 125.7$$

$$\text{Then, } \sigma_c = 84.3 \text{ N/mm}^2$$

Hence, section is safe against axial compression

$$\text{Axial tension capacity of the section} = 2908 * 250/1.15 = 632 \text{ kN} > 357.4 \text{ kN}$$

Hence, section is safe in tension.

Bottom chord design:(c-d)

$$\text{Maximum compressive force} = 324.5 \text{ kN}$$

$$\text{Maximum tensile force} = 169.4 \text{ kN} \quad [\text{Try same section as top chord}]$$

$$\text{Axial tension capacity of the selected section} = 2908 * 250/1.15 = 632 \text{ kN}$$

Hence, section is safe in tension.

$$\text{Axial capacity} = (84.3/1.10) * 2908/1000 = 222.86 \text{ kN} > 184.05 \text{ kN}$$

$$\text{Maximum unrestrained length} = B_y = 2500 \text{ mm}$$

(Assuming every node is restrained by longitudinal tie runner)

$$r_{yy} = 30.3 \text{ mm}$$

$$\lambda_y = 2500/30.3 = 82.5$$

$$\text{Then, } \sigma_c = 145.5 \text{ N/mm}^2$$

$$\text{Axial capacity} = (145.5/1.15) * 2908/1000 = 368 \text{ kN} > 314.85 \text{ kN}$$

Hence, section is safe against axial compression also.

<h1>Structural Steel Design Project</h1> <p>Calculation Sheet</p>	Job No:	Sheet 12 of 13	Rev
	Job Title: <i>ROOF TRUSS</i>		
	<i>Worked Example - 1</i>		
		Made by SSSR	Date 9-2-2000
	Checked by PU	Date 16-08-00	
<p>Web member design:(b-B)</p> <p><i>Maximum compressive force = 121.05 kN</i> <i>Maximum tensile force = 66.9 kN</i></p> <p><i>Try – ISA 80 X 80 X 8.0</i></p> <p>$A = 1221 \text{ mm}^2$ $r_{xx} = 24.4 \text{ mm}$ $r_{uu} = 30.8 \text{ mm}$</p> <p>Section classification:</p> <p>$b/t = 80/8 = 10.0 < 14.0$</p> <p><i>Hence, the section is not slender</i></p> <p><i>Length of member = $(1250^2 + 1250^2)^{0.5} = 1767.5 \text{ mm}$</i></p> <p><i>Slenderness ratio is taken as the greater of</i></p> <p>$0.85 * 1767.5/24.4 = 61.6$ $1.0 * 1767/30.8 = 57.4$</p>			

<h1>Structural Steel Design Project</h1> <p>Calculation Sheet</p>	Job No:	Sheet 13 of 13	Rev
	Job Title: <i>ROOF TRUSS</i>		
	<i>Worked Example - 1</i>		
		Made by SSSR	Date 9-2-2000
	Checked by PU	Date 16-08-00	
<p>Then, $\sigma_c = 182.1 \text{ N/mm}^2$</p> <p>Design compressive strength $= 1221 * (182.1/1.10)/1000$ $= 202.13 \text{ kN} > 121.05 \text{ kN}$</p> <p>Hence, safe in compression.</p> <p>Tensile capacity of the section $= (250/1.10)*1221/1000$ $= 277.5 \text{ kN} > 66.9 \text{ kN}$</p> <p><u>Hence ISA 80 X 80 X 8.0 is adequate for the web member</u></p> <p><i>(The web members away from the support would have lesser axial force but longer and can be redesigned, if so desired)</i></p>			

<h1>Structural Steel Design Project</h1> <p>Calculation Sheet</p>	Job No:	Sheet 1 of 12	Rev
	Job Title: <i>COMPOSITE TRUSS</i>		
	Worked Example - 2		
		Made by SSSR	Date 17-10 -99
	Checked by PU	Date 16-08-00	

PROBLEM 2:

Design a composite truss of span 10.0 m with following data:

DATA:

Span = B = 10.0 m
 Truss spacing = 3.0 m
 Slab thickness = D_s = 150 mm
 Profile depth = D_p = 75.0 mm
 Self weight of deck slab = 2.80 kN/m²
 Maximum laterally un-restrained length in top chord is 1.5 m.
 Grade of concrete, M20 = $(f_{ck})_{cu}$ = 20 MPa

The diagram consists of two parts. The top part is the 'FLOOR PLAN', showing a horizontal line representing the span of 10 m. Vertical dashed lines indicate the positions of the trusses, with a spacing of 3.0 m between them. An arrow points to these lines with the label 'Composite Trusses'. The bottom part is the 'TRUSS ELEVATION', showing a side view of the truss structure over a 10 m span. The truss is a Warren truss with diagonal members connecting the top and bottom chords.

<h1>Structural Steel Design Project</h1> <p>Calculation Sheet</p>	Job No:	Sheet 2 of 12	Rev																																	
	Job Title: <i>COMPOSITE TRUSS</i>																																			
	<i>Worked Example - 2</i>																																			
		Made by SSSR	Date 17-10 -99																																	
	Checked by PU	Date 16-08-00																																		
<p>Loading:</p> <table style="width: 100%; border-collapse: collapse;"> <thead> <tr> <th style="width: 60%;"></th> <th style="width: 20%; text-align: center;"><i>kN/m²</i></th> <th style="width: 20%; text-align: center;"><i>Factored Load (kN/m²)</i></th> </tr> </thead> <tbody> <tr> <td><i>Deck slab weight</i></td> <td style="text-align: center;">2.8</td> <td style="text-align: center;">$2.8 * 1.5 = 4.20$</td> </tr> <tr> <td><i>Truss weight (assumed)</i></td> <td style="text-align: center;">0.4</td> <td style="text-align: center;">$0.4 * 1.5 = 0.60$</td> </tr> <tr> <td><i>Ceiling, floor finish and Services</i></td> <td style="text-align: center;">1.0</td> <td style="text-align: center;">$1.0 * 1.5 = 1.5$</td> </tr> <tr> <td><i>Construction Load</i></td> <td style="text-align: center;">1.0</td> <td style="text-align: center;">$1.0 * 1.5 = 1.5$</td> </tr> <tr> <td><i>Superimposed live load</i></td> <td style="text-align: center;">5.0</td> <td style="text-align: center;">$5.0 * 1.5 = 7.5$</td> </tr> </tbody> </table> <p>PRE-COMPOSITE STAGE:</p> <table style="width: 100%; border-collapse: collapse;"> <thead> <tr> <th style="width: 60%;"></th> <th style="width: 20%; text-align: center;"><i>kN/m²</i></th> <th style="width: 20%; text-align: center;"><i>Factored Load (kN/m²)</i></th> </tr> </thead> <tbody> <tr> <td><i>Deck slab weight</i></td> <td style="text-align: center;">2.8</td> <td style="text-align: center;">$2.8 * 1.5 = 4.20$</td> </tr> <tr> <td><i>Truss weight</i></td> <td style="text-align: center;">0.4</td> <td style="text-align: center;">$0.4 * 1.5 = 0.60$</td> </tr> <tr> <td><i>Construction load</i></td> <td style="text-align: center;">1.0</td> <td style="text-align: center;">$1.0 * 1.5 = 1.5$</td> </tr> <tr> <td style="text-align: right;"><i>Total factored load</i></td> <td></td> <td style="text-align: center;">$= 6.30 \text{ kN/m}^2$</td> </tr> </tbody> </table> <p><i>Choose depth of truss</i> = $\text{Span}/20 = 10000/20 = 500 \text{ mm}$</p> <p><i>Total factored load</i> = $6.30 * 3 = 18.9 \text{ kN/m}$</p> <p><i>Maximum bending moment</i> = $wB^2/8 = 18.9 * 10^2/8 = 240.98 \text{ kN-m}$</p> <p><i>Maximum shear</i> = $wB/2 = 18.9 * 10/2 = 94.50 \text{ kN}$</p> <p><i>Depth of truss (centre to centre distance of chords)</i> = 0.5 m</p> <p><i>Maximum axial compressive force in top chord</i> = $240.98/0.5 = 481.96 \text{ kN}$</p>					<i>kN/m²</i>	<i>Factored Load (kN/m²)</i>	<i>Deck slab weight</i>	2.8	$2.8 * 1.5 = 4.20$	<i>Truss weight (assumed)</i>	0.4	$0.4 * 1.5 = 0.60$	<i>Ceiling, floor finish and Services</i>	1.0	$1.0 * 1.5 = 1.5$	<i>Construction Load</i>	1.0	$1.0 * 1.5 = 1.5$	<i>Superimposed live load</i>	5.0	$5.0 * 1.5 = 7.5$		<i>kN/m²</i>	<i>Factored Load (kN/m²)</i>	<i>Deck slab weight</i>	2.8	$2.8 * 1.5 = 4.20$	<i>Truss weight</i>	0.4	$0.4 * 1.5 = 0.60$	<i>Construction load</i>	1.0	$1.0 * 1.5 = 1.5$	<i>Total factored load</i>		$= 6.30 \text{ kN/m}^2$
	<i>kN/m²</i>	<i>Factored Load (kN/m²)</i>																																		
<i>Deck slab weight</i>	2.8	$2.8 * 1.5 = 4.20$																																		
<i>Truss weight (assumed)</i>	0.4	$0.4 * 1.5 = 0.60$																																		
<i>Ceiling, floor finish and Services</i>	1.0	$1.0 * 1.5 = 1.5$																																		
<i>Construction Load</i>	1.0	$1.0 * 1.5 = 1.5$																																		
<i>Superimposed live load</i>	5.0	$5.0 * 1.5 = 7.5$																																		
	<i>kN/m²</i>	<i>Factored Load (kN/m²)</i>																																		
<i>Deck slab weight</i>	2.8	$2.8 * 1.5 = 4.20$																																		
<i>Truss weight</i>	0.4	$0.4 * 1.5 = 0.60$																																		
<i>Construction load</i>	1.0	$1.0 * 1.5 = 1.5$																																		
<i>Total factored load</i>		$= 6.30 \text{ kN/m}^2$																																		

Structural Steel Design Project

Calculation Sheet

Job No:	Sheet 3 of 12	Rev
Job Title: <i>COMPOSITE TRUSS</i>		
<i>Worked Example - 2</i>		
	Made by SSSR	Date 17-10 -99
	Checked by PU	Date 16-08-00

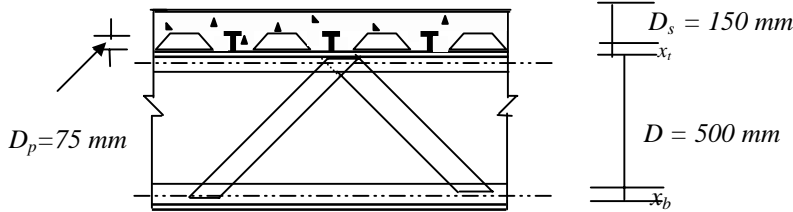

$$D_t = 500 + x_t + x_b$$

Truss configuration: Choose the following truss configuration

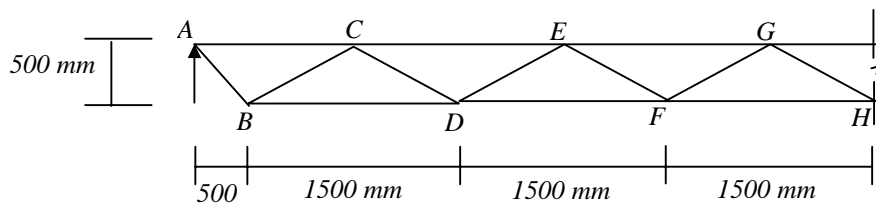

Top chord design:

Try ISNT 150 X 150 X 10 mm @ 0.228 kN/m

Sectional properties:

Area of cross-section = $A_t = 2908 \text{ mm}^2$
 Depth of section = 150 mm
 Width of section, $b = 2b^1 = 150 \text{ mm}$
 Thickness of flange = $T = 10.0 \text{ mm}$
 Thickness of web = $t = 10.0 \text{ mm}$
 Centre of gravity = $x_t = 39.5 \text{ mm}$

$$r_{xx} = 45.6 \text{ mm}$$

$$r_{yy} = 30.3 \text{ mm}$$

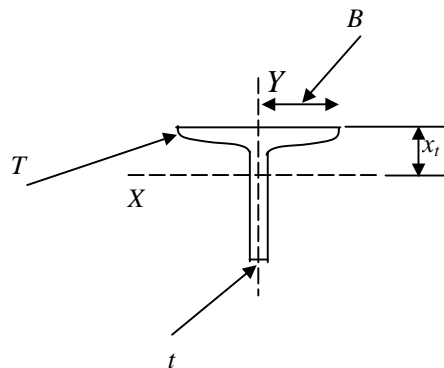

<h1>Structural Steel Design Project</h1> <p>Calculation Sheet</p>	Job No:	Sheet 4 of 12	Rev
	Job Title: <i>COMPOSITE TRUSS</i>		
	<i>Worked Example - 2</i>		
		Made by SSSR	Date 17-10 -99
	Checked by PU	Date 16-08-00	
<p><u>Section classification:</u></p> $\varepsilon = (250/f_y)^{0.5} = (250/250)^{1/2} = 1.0$ <p>Flange:</p> $b^1/T = 75/10 = 7.5 < 8.9\varepsilon \quad \text{Flange is plastic}$ <p>Web:</p> $d/t = 140/10 = 14 (>9.98\varepsilon \text{ and } <19.95\varepsilon) \quad \text{Web is semi-compact}$ <p>As no member in the section is slender, there is no need of adopting reduction factor (Yielding govern).</p> <p>Given, maximum un-restrained length of top chord is 1.5 m during construction stage.</p> <p>Maximum unrestrained length = $B_y = 1500 \text{ mm}$</p> $B_x = 0.85 * 1500 = 1275 \text{ mm}$ $r_{xx} = 45.6 \text{ mm}$ $r_{yy} = 30.3 \text{ mm}$ $\lambda_x = 1275/45.6 = 28$ $\lambda_y = 1500/30.3 = 49.5$ <p>Then, $\sigma_c = 202.8 \text{ N/mm}^2$ [From Table - 3 of Chapter on axially compressed Columns]</p> <p>Axial capacity = $(202.8/1.15) * 2908/1000 = 512.8 \text{ kN} > 437.4 \text{ kN}$</p> <p>Axial capacity = $(202.8/1.1) * 2908/1000 = 536.13 \text{ kN} > 481.96 \text{ kN}$</p> <p><u>Hence, section is safe against axial compression at construction stage.</u></p> <p>[Other member design is governed by composite loading]</p>			

<h1>Structural Steel Design Project</h1> <p>Calculation Sheet</p>	Job No:	Sheet 5 of 12	Rev																														
	Job Title: <i>COMPOSITE TRUSS</i>																																
	<i>Worked Example - 2</i>																																
		Made by SSSR	Date 17-10 -99																														
	Checked by PU	Date 16-08-00																															
<p>COMPOSITE STATE:</p> <table style="width: 100%; border-collapse: collapse;"> <thead> <tr> <th style="width: 60%;"></th> <th style="width: 20%; text-align: center;">kN/m^2</th> <th style="width: 20%; text-align: center;"><i>Factored Load (kN/m²)</i></th> </tr> </thead> <tbody> <tr> <td><i>Deck slab weight</i></td> <td style="text-align: center;">2.8</td> <td style="text-align: center;">$2.8*1.5 = 4.20$</td> </tr> <tr> <td><i>Truss weight (assumed)</i></td> <td style="text-align: center;">0.4</td> <td style="text-align: center;">$0.4*1.5 = 0.60$</td> </tr> <tr> <td><i>Ceiling, floor finish and Services</i></td> <td style="text-align: center;">1.0</td> <td style="text-align: center;">$1.0*1.5 = 1.5$</td> </tr> <tr> <td><i>Superimposed live load</i></td> <td style="text-align: center;">5.0</td> <td style="text-align: center;">$5.0*1.5 = 7.5$</td> </tr> <tr> <td> <i>Total factored load</i></td> <td></td> <td></td> </tr> <tr> <td></td> <td style="text-align: center;">$= (4.2+0.6+1.5+7.5)*3$</td> <td></td> </tr> <tr> <td></td> <td style="text-align: center;">$= 13.8*3$</td> <td style="text-align: center;">$= 41.40 kN/m$</td> </tr> <tr> <td><i>Maximum bending moment (M_c)</i></td> <td></td> <td style="text-align: center;">$= wB^2/8 = 41.4*10^2/8 = 527.85 kN-m$</td> </tr> <tr> <td><i>Maximum shear</i></td> <td></td> <td style="text-align: center;">$= wB/2 = 41.4*10/2 = 207 kN$</td> </tr> </tbody> </table> <p>Bottom chord design:</p> <p>Force in bottom chord, $R_{b,req}$ is given by: [See Fig. of the text]</p> $R_{b,req} \{D + x_t + D_s - (D_s - D_p)/2\} = M_c$ <p>[Assume NA is in the concrete slab]</p> $R_{b,req} (500 + 39.5 + (150 - 37.5))/1000 = 527.85$ $R_{b,req} (652/1000) = 527.85 kN-m$ $R_{b,req} = 527.85/0.652 = 809.59 kN$ <p>Area required $= 809.59*1000/(f_y/1.1)$ $= 809.59*1000/(250/1.1) = 3562.2 mm^2$</p> <p>Trial-1 Trying ISHT 150 @ 0.294kN/m</p> <p>Sectional properties:</p> $A = 3742 mm^2 \quad ; \quad x_b = \text{Centre of gravity} = 26.6 mm$ <p>Width of the section, $b = 2b_1 = 250 mm$</p>					kN/m^2	<i>Factored Load (kN/m²)</i>	<i>Deck slab weight</i>	2.8	$2.8*1.5 = 4.20$	<i>Truss weight (assumed)</i>	0.4	$0.4*1.5 = 0.60$	<i>Ceiling, floor finish and Services</i>	1.0	$1.0*1.5 = 1.5$	<i>Superimposed live load</i>	5.0	$5.0*1.5 = 7.5$	 <i>Total factored load</i>				$= (4.2+0.6+1.5+7.5)*3$			$= 13.8*3$	$= 41.40 kN/m$	<i>Maximum bending moment (M_c)</i>		$= wB^2/8 = 41.4*10^2/8 = 527.85 kN-m$	<i>Maximum shear</i>		$= wB/2 = 41.4*10/2 = 207 kN$
	kN/m^2	<i>Factored Load (kN/m²)</i>																															
<i>Deck slab weight</i>	2.8	$2.8*1.5 = 4.20$																															
<i>Truss weight (assumed)</i>	0.4	$0.4*1.5 = 0.60$																															
<i>Ceiling, floor finish and Services</i>	1.0	$1.0*1.5 = 1.5$																															
<i>Superimposed live load</i>	5.0	$5.0*1.5 = 7.5$																															
 <i>Total factored load</i>																																	
	$= (4.2+0.6+1.5+7.5)*3$																																
	$= 13.8*3$	$= 41.40 kN/m$																															
<i>Maximum bending moment (M_c)</i>		$= wB^2/8 = 41.4*10^2/8 = 527.85 kN-m$																															
<i>Maximum shear</i>		$= wB/2 = 41.4*10/2 = 207 kN$																															

<h1>Structural Steel Design Project</h1> <p>Calculation Sheet</p>	Job No:	Sheet 6 of 12	Rev
	Job Title: <i>COMPOSITE TRUSS</i>		
	<i>Worked Example - 2</i>		
		Made by SSSR	Date 17-10 -99
	Checked by PU	Date 16-08-00	
<p><i>Axial tension capacity of the selected section (R_b):</i></p> $R_b = (250/1.1) * 3742/1000 = 850.46 \text{ kN} > 809.59 \text{ kN}$ <p><u>Hence, O.K.</u></p> <p><u>Capacity of Composite Section in Compression:</u></p> <p><i>Capacity of concrete slab, R_c, is given by</i></p> $R_c = 0.45 (f_{ck})_{cu} * b_{eff} * (D_s - D_p)$ <p><i>Effective width of the slab, b_{eff}:</i> [See the chapter Composite beams – II]</p> $b_{eff} \leq B/4 = 10000/4 = 2500 \text{ mm}$ <p><i>Therefore, $b_{eff} = 2500 \text{ mm}$</i></p> $R_c = 0.45 * 20 * 2500 * 75/1000 \quad \{f_{ck} = 20 \text{ N/mm}^2\}$ $= 1687.5 \text{ kN} > R_b \quad \text{(tension governs)}$ <p><i>Neutral axis depth :</i></p> $x_c = (D_s - D_p) * 850.46/1687.5 = 75 * 850.46/1687.5 = 37.8 \text{ mm}$ $D_t = 0.5 + 0.0266 + 0.0395 = 0.566 \text{ mm}$ <p><i>Then, maximum moment it can carry</i></p> $M_{u, design} = 850.46(0.566 + 0.15 - 0.5 * 0.0378 - 0.0266)$ $= 570.23 \text{ kN-m} > 527.85 \text{ kN-m}$ <p><u>Hence, the slab and chord members are designed.</u></p>			

<h1>Structural Steel Design Project</h1> <p>Calculation Sheet</p>	Job No:	Sheet 7 of 12	Rev
	Job Title: <i>COMPOSITE TRUSS</i>		
	<i>Worked Example - 2</i>		
		Made by SSSR	Date 17-10 -99
	Checked by PU	Date 16-08-00	
<p>Web members:</p> <div style="text-align: center;"> </div> <p> $F_{AB} = V(1.414) = 207(1.414) = 292.7 \text{ kN (tension)}$ </p> <p> $F_{BC} = (V - 0.5 * 39.5) (500^2 + 750^2)^{0.5} / 500 = 335.86 \text{ kN (compression)}$ </p> <p> $F_{CD} = (V - 2.0 * 39.5) (500^2 + 750^2)^{0.5} / 500 = 223.91 \text{ kN (tension)}$ </p> <p> Hence, maximum tensile force in bracing members = 292.7 kN Maximum compressive force in bracing members = 335.86 kN </p> <p>Design of tension members:</p> <p> Trial gross area required = $292.7 * 10^3 / (250 / 1.1) = 1287.88 \text{ mm}^2$ </p> <p>Trying 2 – ISA 70 X 70 X 6.0 @ 0.126 kN/m</p> <p> $A_{\text{gross provided}} = 2 * 806 = 1612 \text{ mm}^2$ </p> <p>Effective area:</p> <p>(Assume, angle is welded to T- section)</p> <p> $A_{\text{net effective}} = 1612 \text{ mm}^2$ Axial tension capacity = $A_e * (f_y / \gamma_m)$ = $1612 * 250 / 1.1$ = $366.36 \text{ kN} > 292.7 \text{ kN}$ </p> <p><u>Hence, 2 – ISA 70 X 70 X 6.0 are adequate</u></p>			

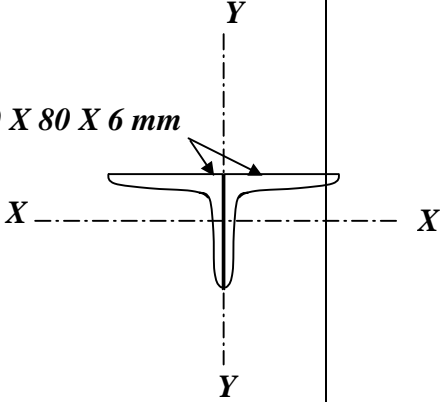
<h1>Structural Steel Design Project</h1> <p>Calculation Sheet</p>	Job No:	Sheet 8 of 12	Rev
	Job Title: <i>COMPOSITE TRUSS</i>		
	<i>Worked Example - 2</i>		
		Made by SSSR	Date 17-10 -99
	Checked by PU	Date 16-08-00	
<p>Design of compression member:</p> <p>Maximum compressive load = 320 kN Trying 2 – ISA 80 X 80 X 6.0 @ 0.146 kN/m</p> <p> $A = 1858 \text{ mm}^2$ $r_{xx} = 24.6 \text{ mm}$ $r_{yy} = 34.9 \text{ mm}$ </p> <p>Section classification:</p> <p>$b/t = 80/6 = 13.3 < 15.75\varepsilon$</p> <p>Hence, the section is not slender and no need to apply any reduction factor.</p> <p>Slenderness ratio is taken as the greater of</p> <p> Length of member = $(750^2 + 500^2)^{0.5} = 901 \text{ mm}$ $\lambda_{xx} = 0.85 * 901/24.6 = 31.1$ $\lambda_{yy} = 1.0 * 901/34.9 = 25.8$ </p> <p>Design buckling strength = $\sigma_c = 231.2 \text{ Mpa}$ [Table – 3 of chapter on axially compressed columns]</p> <p>Design compressive strength = $1858 * (231.2/1.1)/10^3 = 390.52 \text{ kN} > 335.86 \text{ kN}$</p> <p><u>Hence the 2 – ISA 80 X 80 X 6.0 are adequate for the web members</u></p> <p><i>(The web members away from the support would have lesser axial force and can be redesigned, if so desired. Preferably use the same section for all web members)</i></p>			
			

<h1>Structural Steel Design Project</h1> <p>Calculation Sheet</p>	Job No:	Sheet 9 of 12	Rev
	Job Title: <i>COMPOSITE TRUSS</i>		
	<i>Worked Example - 2</i>		
		Made by <i>SSSR</i>	Date <i>17-10 -99</i>
	Checked by <i>PU</i>	Date <i>16-08-00</i>	

Weight Schedule:

Description	Section mm X mm X mm	Weight kN/m	Number	Length (m)	Total Length (m)	Weight kN
<i>Top Chord</i>	<i>ISNT 150 X150X10</i>	<i>0.228</i>	<i>1</i>	<i>10.0</i>	<i>10.0</i>	<i>2.28</i>
<i>Bottom Chord</i>	<i>ISHT 150</i>	<i>0.294</i>	<i>1</i>	<i>10.0</i>	<i>10.0</i>	<i>2.94</i>
<i>Bracing Members</i>	<i>2-ISA 70 X 70 X 6</i>	<i>0.126</i>	<i>2</i>	<i>0.71</i>	<i>1.42</i>	<i>0.18</i>
<i>Tension Members</i>	<i>2-ISA 70 X 70 X 6</i>	<i>0.126</i>	<i>6</i>	<i>0.9</i>	<i>5.4</i>	<i>0.68</i>
<i>Compression Members</i>	<i>2-ISA 80 X 80 X 6</i>	<i>0.146</i>	<i>6</i>	<i>0.9</i>	<i>5.4</i>	<i>0.79</i>
						<i>6.87</i>
<i>Allow 2 1/2 % Extras</i>						<i>0.17</i>
						<i>7.04</i>

Average weight per unit area of floor

$$= \frac{7.04}{10 \times 3} = 0.23 \text{ kN/m}^2 < 0.4 \text{ kN/m}^2 \text{ (Assumed)}$$

Hence, O.K.

<h1>Structural Steel Design Project</h1> <p>Calculation Sheet</p>	Job No:	Sheet 10 of 12	Rev														
	Job Title: <i>COMPOSITE TRUSS</i>																
	<i>Worked Example - 2</i>																
		Made by SSSR	Date 17-10 -99														
	Checked by PU	Date 16-08-00															
<p>Deflection:</p> <p><i>Pre-composite stage:</i></p> <p>The second moment of area of the steel truss, I_t can be calculated from the following equation.</p> $I_t = \frac{A_b A_t}{(A_b + A_t)} [D_t - x_b - x_t]^2$ <p>Where,</p> <p>A_b - Cross-sectional area of bottom chord. A_t - Cross-sectional area of top chord.</p> <p>In this problem,</p> <p>$A_b = 3742 \text{ mm}^2$ $x_b = 26.6 \text{ mm}$ $A_t = 2908 \text{ mm}^2$ $x_t = 39.5 \text{ mm}$ $D_t = 566 \text{ mm}$</p> $I_t = \frac{3742 \times 2908}{(3742 + 2908)} [566 - 26.6 - 39.5]^2$ $= 409 \times 10^6 \text{ mm}^4$																	
<p>Loading:</p> <table style="width: 100%; border-collapse: collapse;"> <tr> <td></td> <td style="text-align: right;">kN/m^2</td> </tr> <tr> <td>Deck slab weight</td> <td style="text-align: right;">2.80</td> </tr> <tr> <td>Truss weight</td> <td style="text-align: right;">0.23</td> </tr> <tr> <td>Construction load</td> <td style="text-align: right;">1.00</td> </tr> <tr> <td></td> <td style="text-align: right;">-----</td> </tr> <tr> <td></td> <td style="text-align: right;">4.03</td> </tr> <tr> <td> Total Load</td> <td style="text-align: right;"> $= 4.03 * 3 * 10 = 121 \text{ kN}$</td> </tr> </table>					kN/m^2	Deck slab weight	2.80	Truss weight	0.23	Construction load	1.00		-----		4.03	 Total Load	 $= 4.03 * 3 * 10 = 121 \text{ kN}$
	kN/m^2																
Deck slab weight	2.80																
Truss weight	0.23																
Construction load	1.00																

	4.03																
 Total Load	 $= 4.03 * 3 * 10 = 121 \text{ kN}$																

<h1>Structural Steel Design Project</h1> <p>Calculation Sheet</p>	Job No:	Sheet 11 of 12	Rev
	Job Title: <i>COMPOSITE TRUSS</i>		
	<i>Worked Example - 11</i>		
		Made by SSSR	Date 17-10 -99
	Checked by PU	Date 16-08-00	
<p>Deflection at pre composite state is given by</p> $\delta_0 = (5 \cdot 121 \cdot 10000^3) / (384 \cdot 200 \cdot 409 \cdot 10^6) = 19.3 \text{ mm}$ <p>Deflection at composite state due to dead load = $\delta_1 = (3.03/4.03) \cdot 19.3$ $= 14.5 \text{ mm}$</p> <p>[For composite stage construction load has to removed for calculating deflections]</p> <p>Deflection - Composite stage:</p> <p>The second moment of area, I_c, of a composite truss can be calculated from the following equation</p> $I_c = \frac{A_b A_c / m}{(A_b + A_c / m)} \left[D_t + (D_s + D_p) / 2 - x_b \right]^2$ <p>Where,</p> <p>A_c = Cross-sectional area of the concrete in the effective breadth of slab $= (D_s - D_p) b_{\text{eff}}$</p> <p>$m$ = modular ratio</p> <p>In this problem,</p> <p>A_b = 3742 mm²; $b_{\text{eff}} = 2500 \text{ mm}$ A_c = (150 - 75) * 2500 = 1875 * 10² mm² m = 15 (light weight concrete) D_t = 566 mm x_b = 26.6 mm</p> $I_c = \frac{3742 \times 1875 \times 10^2 / 15}{(3742 + 1875 \times 10^2 / 15)} \left[566 + \frac{225}{2} - 26.6 \right]^2$ $= 1224 \times 10^6 \text{ mm}^4$			

<h1>Structural Steel Design Project</h1> <p>Calculation Sheet</p>	Job No:	Sheet 12 of 12	Rev
	Job Title: <i>COMPOSITE TRUSS</i>		
	<i>Worked Example - 12</i>		
		Made by SSSR	Date 17-10 -99
	Checked by PU	Date 16-08-00	
<p>Loading:</p> <p><i>Super Imposed load</i> = 5.0 kN/m²</p> <p><i>Total Load</i> = 5.0*3*10=150 kN</p> <p><i>Deflection at composite state due to superimposed load is given by</i></p> $\delta_2 = (5*150*10000^3)/(384* 200* 1224*10^6) = 8.0 \text{ mm}$ <p><i>10% allowance is given</i></p> <p><i>Then, $\delta_2 = 8.8 \text{ mm} < B/360 = 10000/360 = 28 \text{ mm}$</i></p> <p><i>Total deflection = $\delta_1 + \delta_2 = 14.5 + 8.8 = 23.3 \text{ mm} (B/429) < (B/325)$</i></p> <p><i>Hence, design is O.K.</i></p>			